



Surface Mount Super fast Recovery Bridge Rectifier

Reverse Voltage –100 to 600 V

Forward Current – 2 A

FEATURES

- For surface mounted applications
- Low profile package
- Glass Passivated Chip Junction
- Super fast reverse recovery time
- Lead free in comply with EU RoHS 2011/65/EU directives

MECHANICAL DATA

- Case: ABS/LBF
- Terminals: Solderable per MIL-STD-750, Method 2026
- Approx. Weight: 88mg/0.0031oz

PINNING

PIN	DESCRIPTION
1	Input Pin (~)
2	Input Pin (~)
3	Output Anode (+)
4	Output Cathode (-)

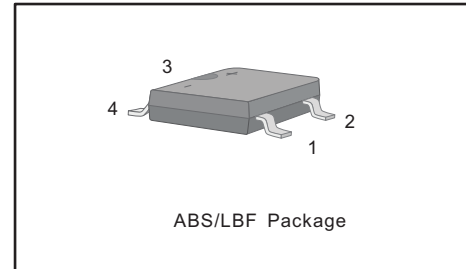

Absolute Maximum Ratings and Characteristics

Ratings at 25 °C ambient temperature unless otherwise specified. Single phase, half wave, 60 Hz, resistive or inductive load. For capacitive load, derate current by 20%.

Parameter	Symbols	ETB1S-20	ETB2S-20	ETB4S-20	ETB6S-20	Units
Maximum Repetitive Peak Reverse Voltage	V_{RRM}	100	200	400	600	V
Maximum RMS voltage	V_{RMS}	70	140	280	420	V
Maximum DC Blocking Voltage	V_{DC}	100	200	400	600	V
Maximum Average Forward Rectified Current at $T_c = 125\text{ }^\circ\text{C}$	$I_{F(AV)}$	2				A
Peak Forward Surge Current 8.3 ms Single Half Sine Wave Superimposed on Rated Load	I_{FSM}	60				A
Maximum Forward Voltage at 2 A	V_F	0.95		1.25	1.70	V
Maximum DC Reverse Current $T_a = 25\text{ }^\circ\text{C}$ at Rated DC Blocking Voltage $T_a = 125\text{ }^\circ\text{C}$	I_R		5 100			μA
Typical Junction Capacitance (Note: 1)	C_j		40			pF
Maximum Reverse Recovery Time (Note: 2)	t_{rr}		35			ns
Typical Thermal Resistance (Note: 3)	$R_{\theta JA}$		80			$^\circ\text{C/W}$
Operating and Storage Temperature Range	T_j, T_{stg}		-55 ~ +150			$^\circ\text{C}$

Note: 1. Measured at 1MHz and applied reverse voltage of 4 V D.C.
2. Measured with $I_f = 0.5\text{ A}$, $I_R = 1\text{ A}$, $I_{rr} = 0.25\text{ A}$.
3. Mounted on glass epoxy PC board with $4 \times 1.5 \times 1.5$ " (3.81×3.81 cm) copper pad.



Fig.1 Reverse Recovery Time Characteristic And Test Circuit Diagram

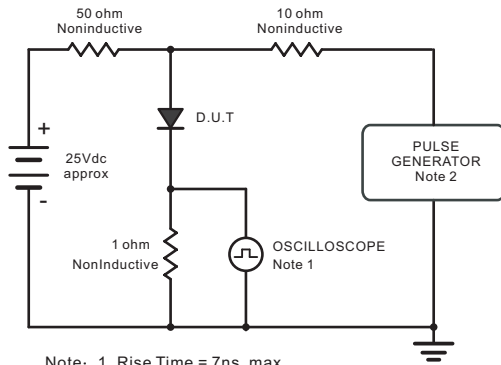

Note: 1. Rise Time = 7ns, max.
Input Impedance = 1megohm, 22pF.
2. Rises Time = 10ns, max.
Source Impedance = 50 ohms.

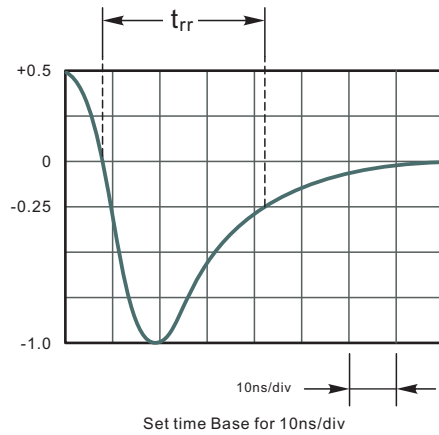

Fig.2 Maximum Average Forward Current Rating

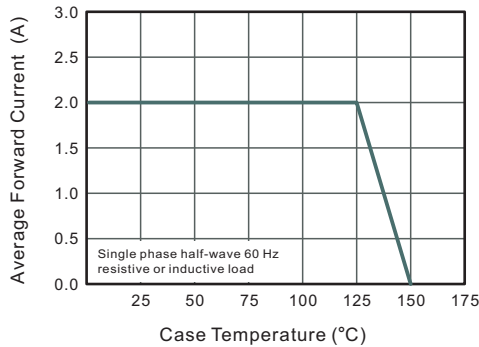

Fig.3 Typical Reverse Characteristics

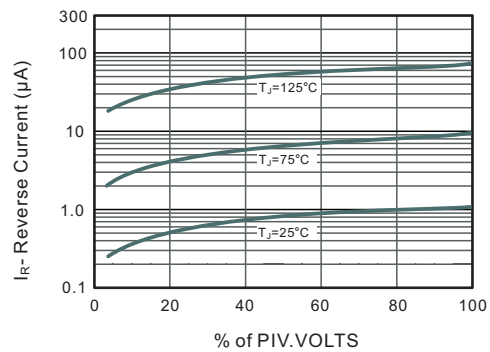

Fig.4 Typical Forward Characteristics

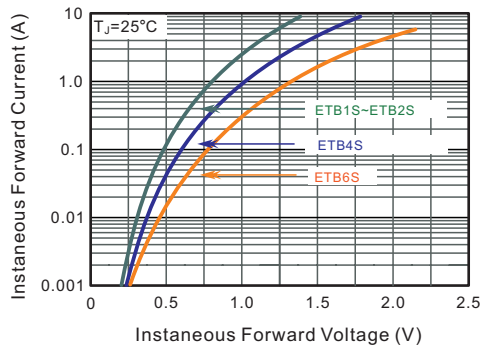

Fig.5 Typical Junction Capacitance

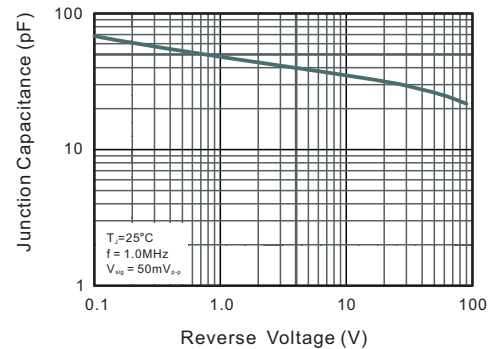
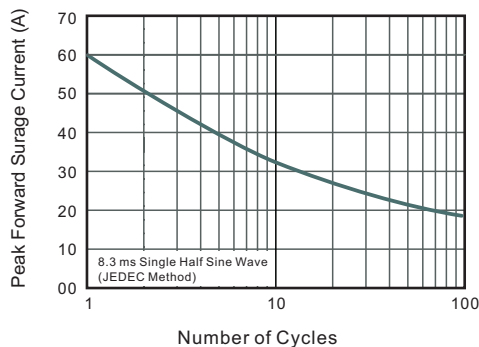

Fig.6 Maximum Non-Repetitive Peak Forward Surge Current





PACKAGE OUTLINE

Plastic surface mounted package; 4 leads

ABS/LBF

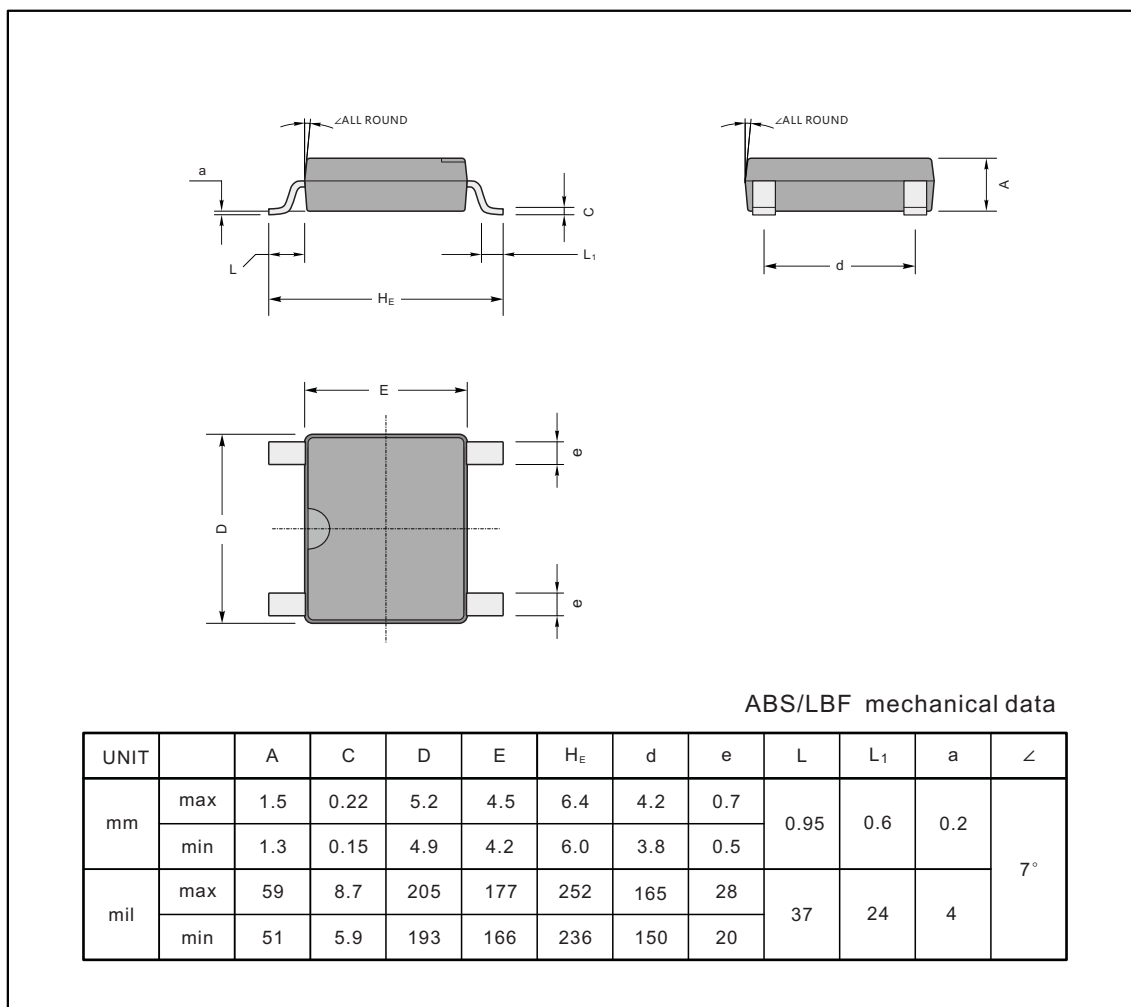

The recommended mounting pad size

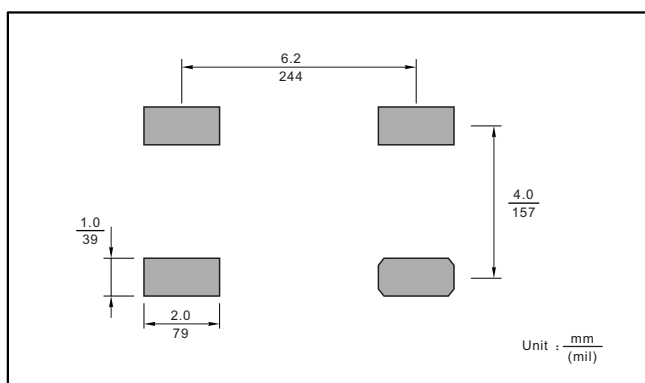

Marking

Type number	Marking code
ETB1S-20	ETB1S
ETB2S-20	ETB2S
ETB4S-20	ETB4S
ETB6S-20	ETB6S