

## 4A, 600V N-CHANNEL POWER MOSFET

ITO-220ABW

### DESCRIPTION

The F4N60 is a high voltage power MOSFET and is designed to have better characteristics, such as fast switching time, low gate charge, low on-state resistance and have a high rugged avalanche characteristics. This power MOSFET is usually used at high speed switching applications in switching power supplies and adaptors.

### Features

- $R_{DS(ON)} \leq 2.5 \Omega$  @  $V_{GS}=10V, I_D=2.0A$
- Fast switching capability
- Avalanche energy tested
- Improved dv/dt capability, high ruggedness

### Mechanical data

- Case: ITO-220ABW
- Approx. Weight: 2.1g ( 0.07oz)
- Lead free finish, RoHS compliant
- Case Material: "Green" molding compound, UL flammability classification 94V-0, "Halogen-free".

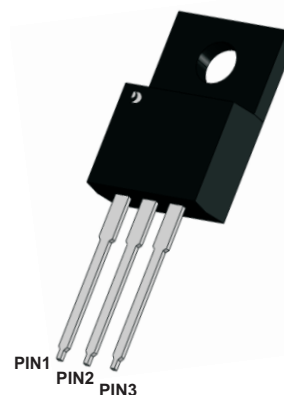

### SYMBOL

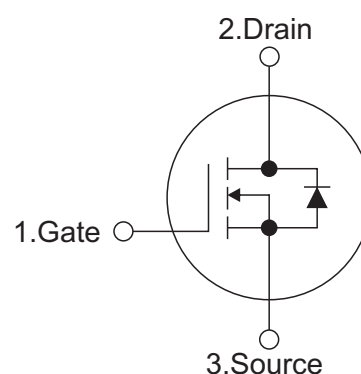

### ABSOLUTE MAXIMUM RATINGS (TA=25°C, unless otherwise specified)

PARAMETER	Symbols	RATINGS	Units	
Drain-Source Voltage	$V_{DSS}$	600	V	
Gate-Source Voltage	$V_{GSS}$	$\pm 30$	V	
Continuous Drain Current	$I_D$	$T_c=25^\circ C$	4	A
		$T_c=100^\circ C$	2.5	A
Pulsed Drain Current (Note 2)	$I_{DM}$	16	A	
Avalanche Energy Single Pulsed (Note 3)	$E_{AS}$	173	mJ	
Peak Diode Recovery dv/dt (Note 4)	dv/dt	2.1	V/ns	
Power Dissipation	$P_D$	43	W	
Operation Junction Temperature and Storage Temperature	$T_j, T_{stg}$	-55 ~ +150	$^\circ C$	

Notes: 1. Absolute maximum ratings are those values beyond which the device could be permanently damaged.

Absolute maximum ratings are stress ratings only and functional device operation is not implied.

2. Repetitive Rating: Pulse width limited by maximum junction temperature.

3. L = 100mH, IAS = 4.1A, VDD = 50V, RG = 25  $\Omega$ , Starting TJ = 25 $^\circ C$

4. ISD  $\leq$  10A, di/dt  $\leq$  200A/ $\mu s$ , VDD  $\leq$  BVDSS, Starting TJ = 25 $^\circ C$

### THERMAL DATA

PARAMETER	Symbols	RATINGS	Units
Junction to Ambient	$R_{thJA}$	63	$^\circ C/W$
Junction to Case	$R_{thJC}$	2.9	$^\circ C/W$



**ELECTRICAL CHARACTERISTICS (TA=25°C, unless otherwise specified)**

PARAMETER		Symbols	TEST CONDITIONS	Min	Typ	Max	Units	
<b>OFF CHARACTERISTICS</b>								
Drain-Source Breakdown Voltage		$BV_{DSS}$	$V_{GS}=0V, I_D=250\mu A$	600			V	
Drain-Source Leakage Current		$I_{DSS}$	$V_{DS}=600V, V_{GS}=0V$			1	$\mu A$	
Gate- Source Leakage Current	Forward	$I_{GSS}$	$V_{GS}=30V, V_{DS}=0V$			100	nA	
	Reverse		$V_{GS}=-30V, V_{DS}=0V$			-100		
<b>ON CHARACTERISTICS</b>								
Gate Threshold Voltage		$V_{GS(TH)}$	$V_{DS}=V_{GS}, I_D=250\mu A$	2.0		4.0	V	
Static Drain-Source On-State Resistance		$R_{DS(ON)}$	$V_{GS}=10V, I_D=2.0A$		2.04	2.5	$\Omega$	
<b>DYNAMIC CHARACTERISTICS</b>								
Input Capacitance		$C_{ISS}$	$V_{DS}=25V,$ $V_{GS}=0V,$ $f=1.0MHz$		564		pF	
Output Capacitance		$C_{OSS}$				66		pF
Reverse Transfer Capacitance		$C_{RSS}$				12		pF
<b>SWITCHING CHARACTERISTICS</b>								
Total Gate Charge (Note 1)		$Q_G$	$V_{DS}=480V, V_{GS}=10V,$ $I_D=4A, I_G=1mA$ (NOTE1,2)		13		nC	
Gate-Source Charge		$Q_{GS}$				4		nC
Gate-Drain Charge		$Q_{GD}$				2.2		nC
Turn-On Delay Time (Note 1)		$t_{D(ON)}$	$V_{DS}=100V, V_{GS}=10V,$ $I_D=4A, R_G=25\Omega$ (NOTE1,2)		7		ns	
Turn-On Rise Time		$t_R$				16		ns
Turn-Off Delay Time		$t_{D(OFF)}$				36		ns
Turn-Off Fall Time		$t_F$				22		ns
<b>DRAIN-SOURCE DIODE CHARACTERISTICS AND MAXIMUM RATINGS</b>								
Maximum Body-Diode Continuous Current		$I_S$				4	A	
Maximum Body-Diode Pulsed Current		$I_{SM}$				16	A	
Drain-Source Diode Forward Voltage (Note 1)		$V_{SD}$	$I_S=4A, V_{GS}=0V$			1.4	V	
Reverse Recovery Time (Note 1)		$t_{rr}$	$I_S=4A, V_{GS}=0V,$		250		ns	
Reverse Recovery Charge		$Q_{rr}$	$di/dt=100A/\mu s$		4.5		$\mu C$	

Notes:

1. Pulse Test: Pulse width  $\leq 300\mu s$ , Duty cycle  $\leq 2\%$ .
2. Essentially independent of operating temperature.



Test Circuits and waveforms

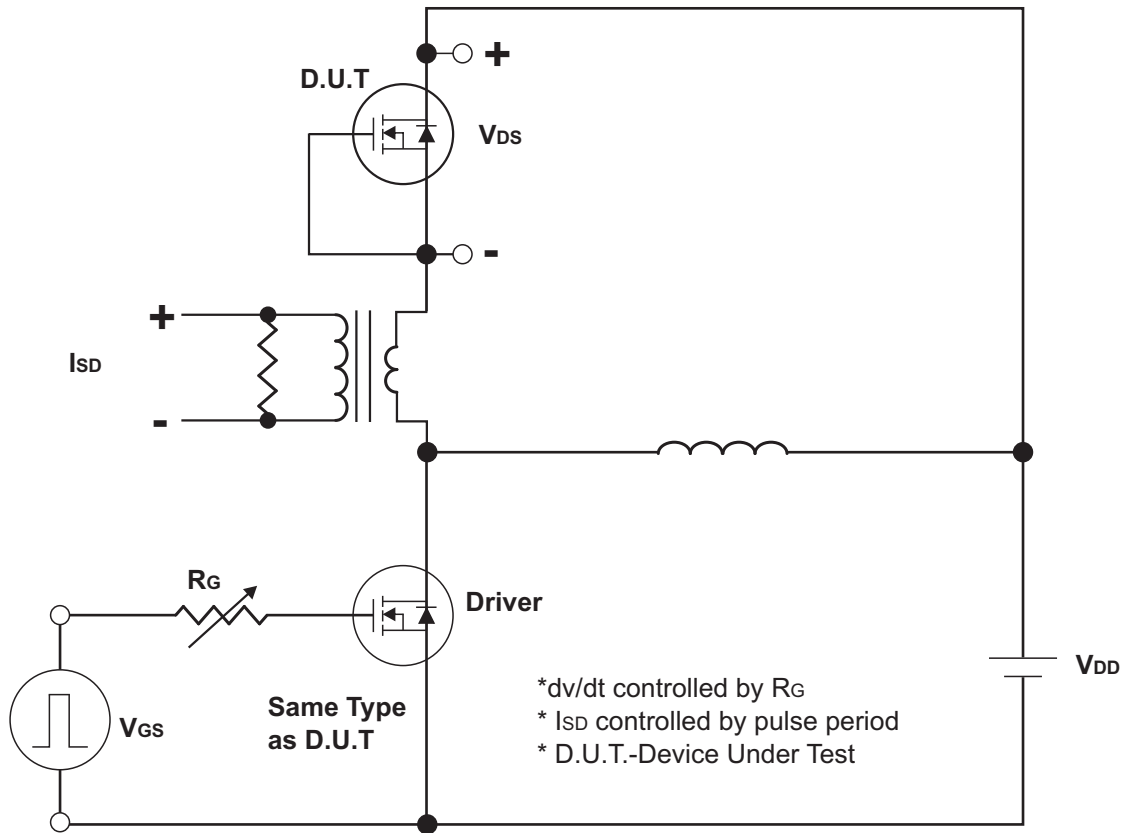

Peak Diode Recovery dv/dt Test Circuit

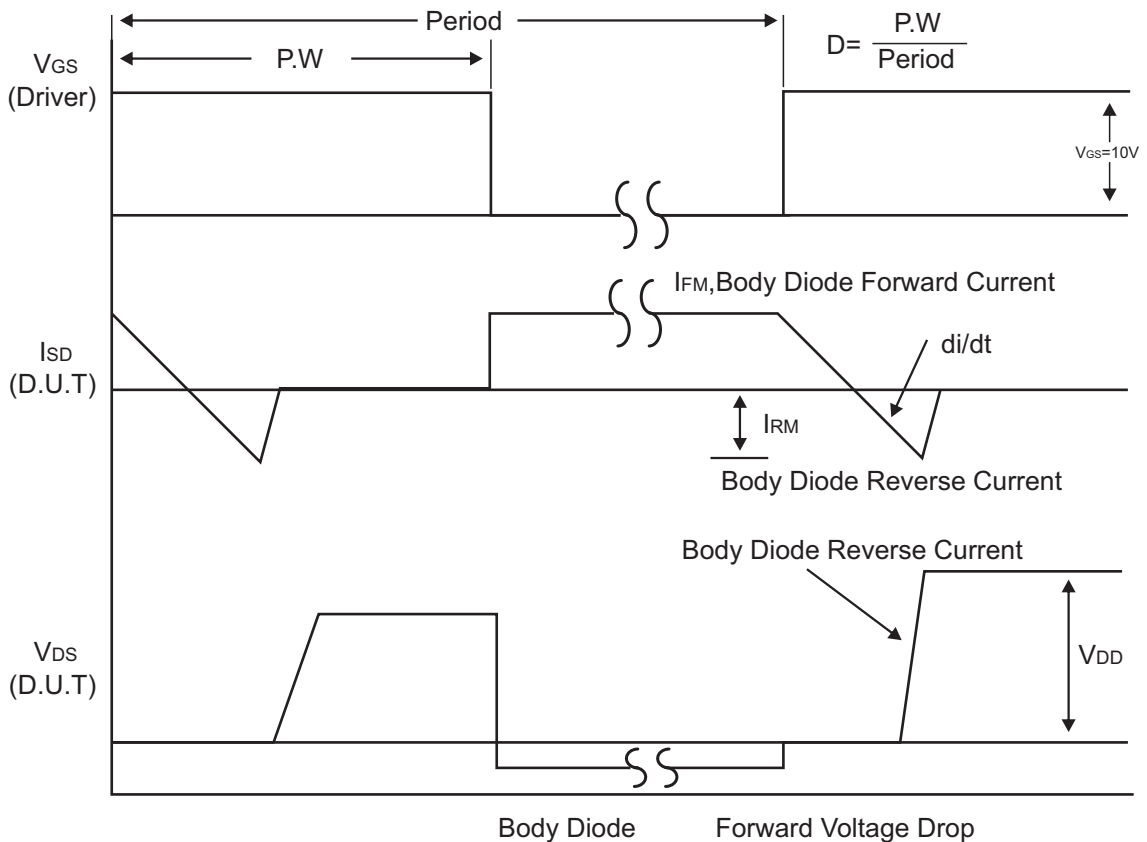

Peak Diode Recovery dv/dt Waveforms



### Test Circuits and waveforms

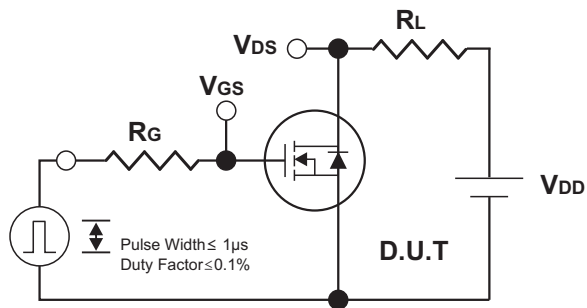

Switching Test Circuit

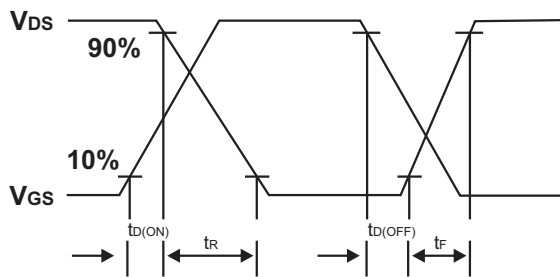

Switching Waveforms

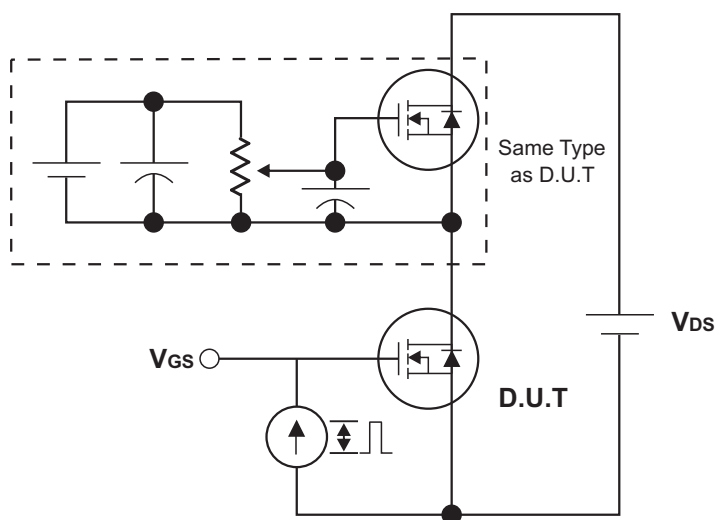

Gate Charge Test Circuit

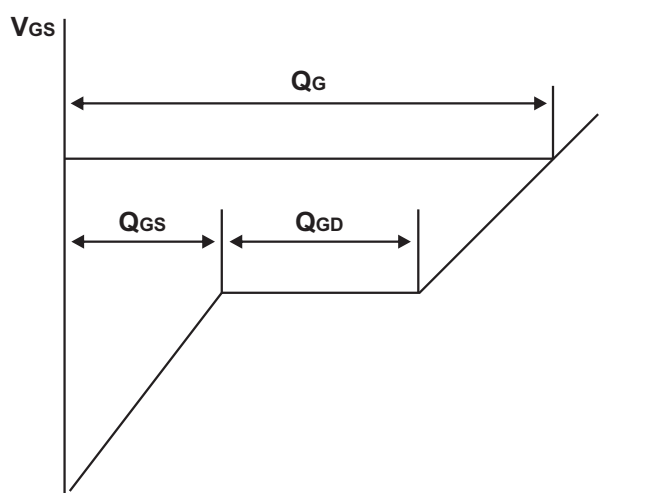

Charge  
Gate Charge Waveform

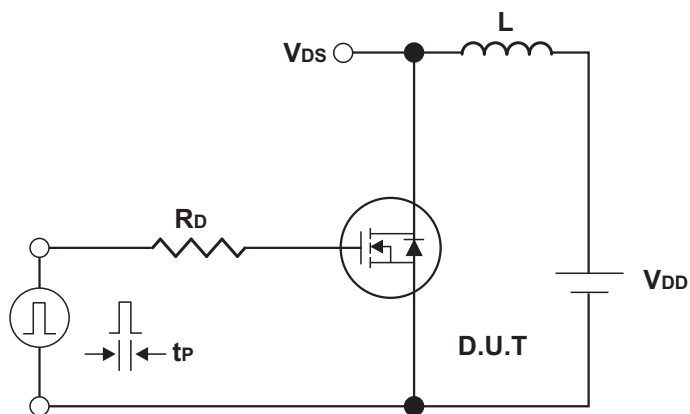

Unclamped Inductive Switching Test Circuit

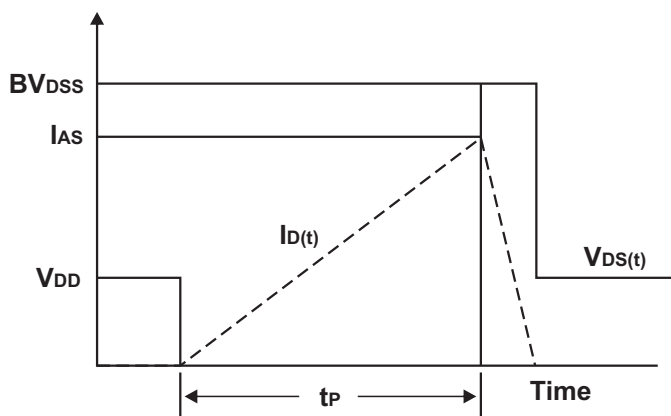

Unclamped Inductive Switching Waveforms



### Typical Characteristics

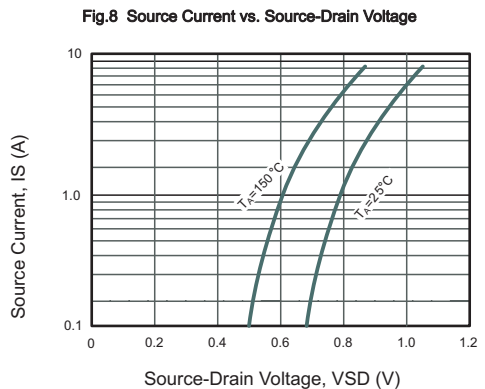
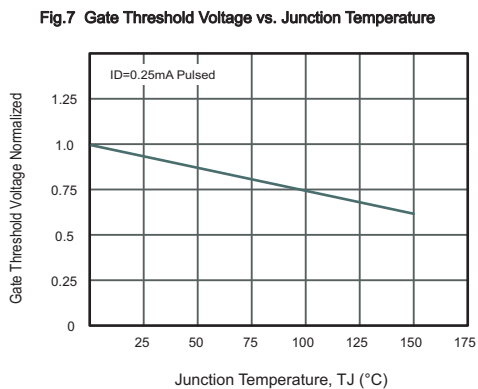
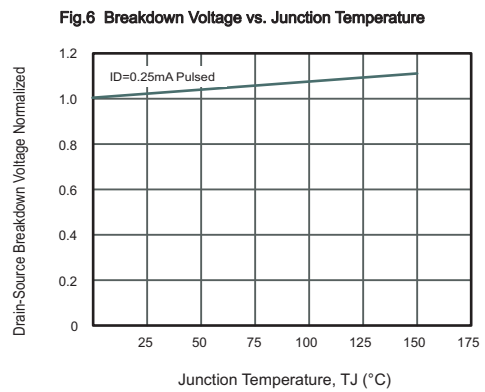
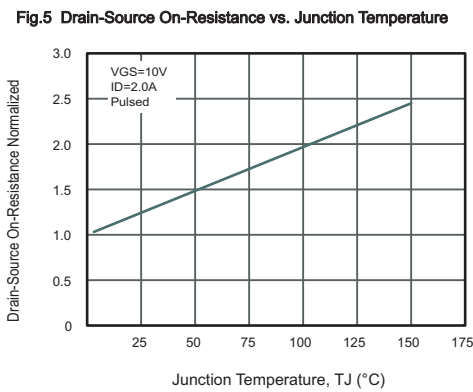
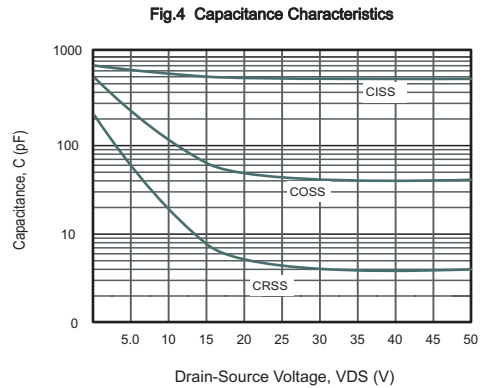
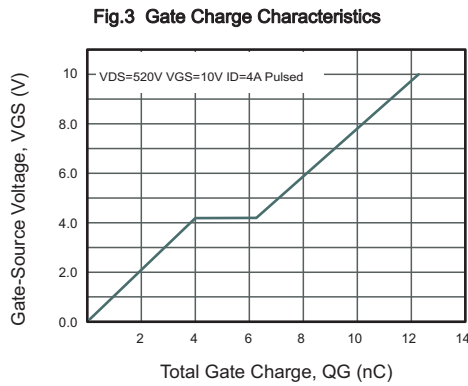
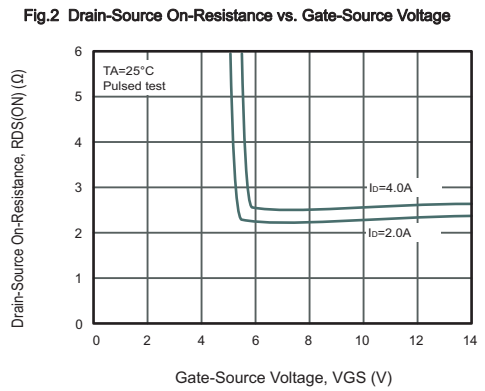
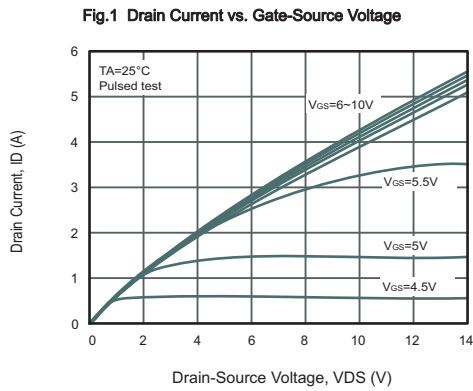



## Typical Characteristics

Fig.9 Drain Current vs. Gate-Source Voltage

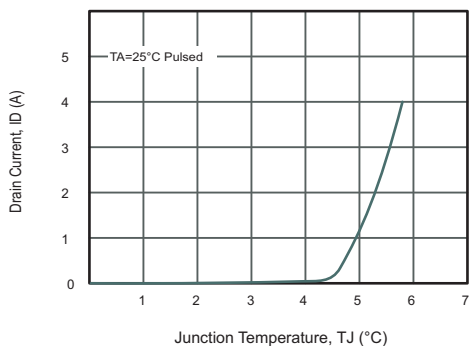

Fig.10 Drain-Source On-Resistance vs. Drain Current

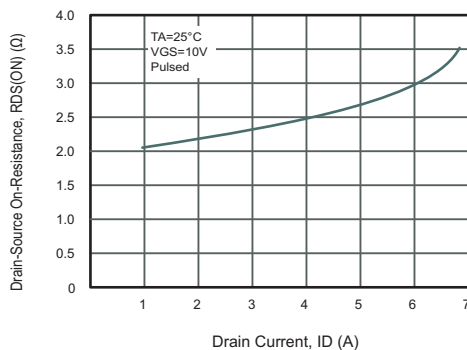

Fig.11 Drain Current vs. Junction Temperature

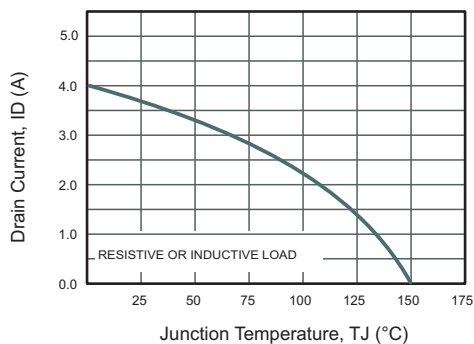

Fig.12 Power Dissipation vs. Junction Temperature

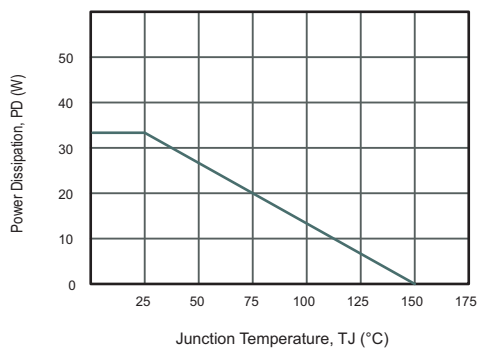
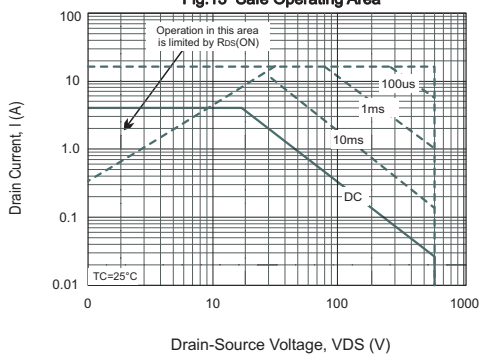

Fig.13 Safe Operating Area





PACKAGE OUTLINE  
Plastic surface mounted package; 3 leads

ITO-220ABW

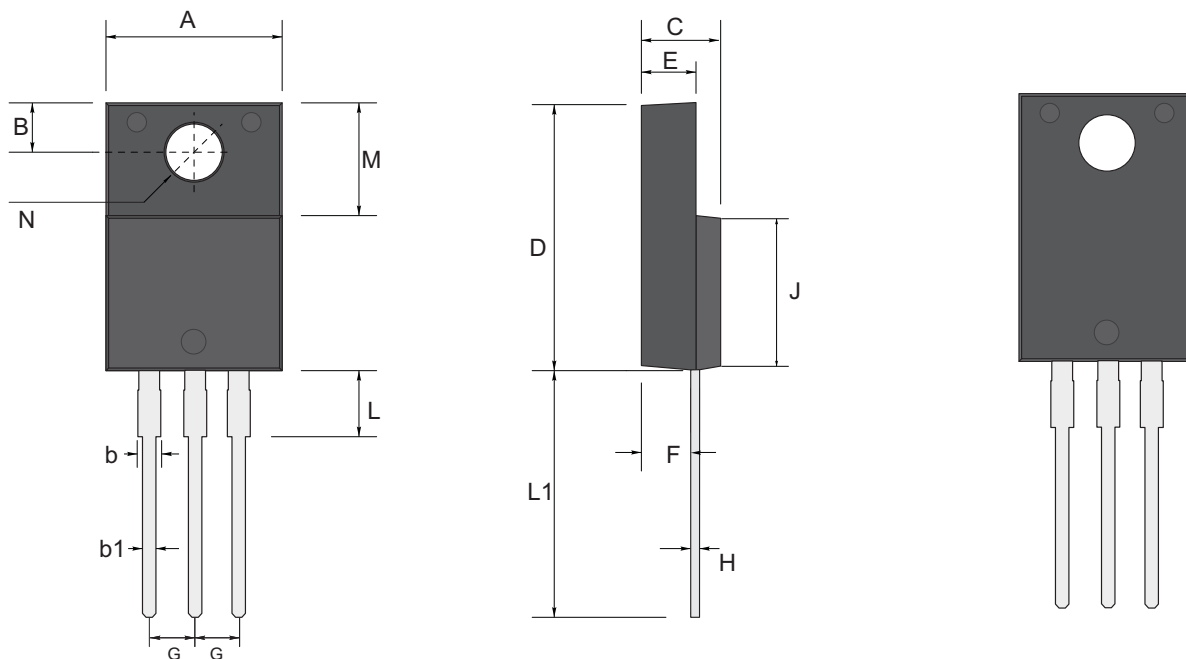

ITO-220ABW mechanical data

UNIT		A	B	b	b1	C	D	E	F	G	H	L	L1	M	N
mm	max	10.5	2.85	1.4	0.8	4.7	16.0	2.9	2.8	2.54 TYPICAL	0.70	2.9	14.3	7.0	3.4 TYPICAL
	typ	10.0	2.70	1.2	0.6	4.5	15.0	2.7	2.7		0.55	2.5	13.5	6.8	
	min	9.85	2.54	1.1	0.5	4.4	14.7	2.5	2.5		0.41	2.3	13.0	6.3	
mil	max	413	112	55	31	185	630	114	110	100 TYPICAL	27	114	563	276	133 TYPICAL
	typ	394	106	47	24	177	590	106	106		22	98	531	267	
	min	388	100	43	20	173	580	98	98		16	91	512	248	

**MARKING DIAGRAM**

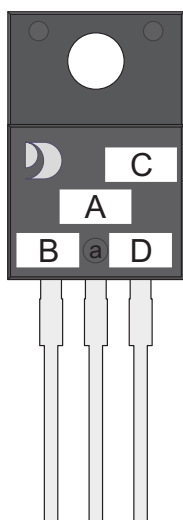

- Unmarkable Surfacea
- Marking Composition Field
- a: Ejector Pin Mark
- A: Marking Area
- B: Lot Code
- C: Additional Information
- D: Date Code (YWW)
- Y: Years(0~9)
- WW: Week



### **Important Notice and Disclaimer**

Jingdao Microelectronics reserves the right to make changes to this document and its products and specifications at any time without notice. Customers should obtain and confirm the latest product information and specifications before final design, purchase or use.

Jingdao Microelectronics makes no warranty, representation or guarantee regarding the suitability of its products for any particular purpose, nor does Jingdao Microelectronics assume any liability for application assistance or customer product design.

Jingdao Microelectronics does not warrant or accept any liability with products which are purchased or used for any unintended or unauthorized application.

No license is granted by implication or otherwise under any intellectual property rights of Jingdao Microelectronics.

Jingdao Microelectronics products are not authorized for use as critical components in life support devices or systems without express written approval of Jingdao Microelectronics.