



105A, 60V N-CHANNEL POWER MOSFET

PDFN5060-8L(Prefix :L)

Description

This model is an n-channel enhanced MOS power field effect transistor manufactured by silicon epitaxial process.

This model has excellent switching characteristics, extremely low on impedance, low gate charge and other characteristics.

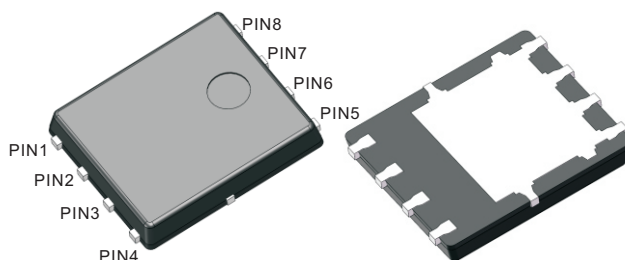

Features

- $R_{DS(ON)} < 3.0 \text{ m}\Omega @ V_{GS}=10\text{V}, I_D=20\text{A}$
- Extremely low on impedance
- Low gate charge
- Superior switching characteristics

Mechanical data

- Case: PDFN5060-8L
- Approx. Weight:0.093g (0.0032oz)
- Lead free finish, RoHS compliant
- Case Material: "Green" molding compound, UL flammability classification 94V-0, "Halogen-free".

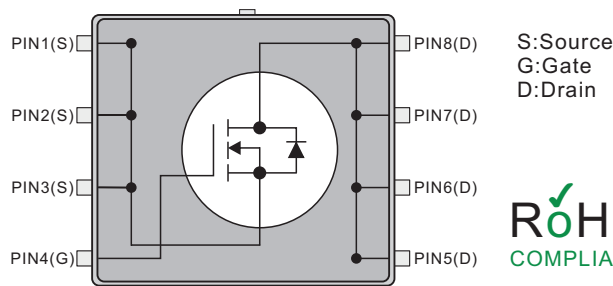

RoHS
COMPLIANT

Packing Marking And Ordering Information

Device Package	Device	Marking	Packing Type	QTY Per Reel	Inner box	Per Carton
PDFN5060-8L	L2R2NS60P	L2R2NS60P	Reel	5,000 Pcs	10,000 Pcs	50,000 Pcs

Absolute Maximum Ratings (TA=25°C, Unless Otherwise Specified)

Parameter	Symbols	Ratings	Units
Drain-Source Voltage	V_{DSS}	60	V
Gate-Source Voltage	V_{GSS}	± 20	V
Continuous Drain Current	I_D	105 70	A
		$T_c=25^\circ\text{C}$ $T_c=100^\circ\text{C}$	
Pulsed Drain Current (Note 2)	I_{DM}	420	A
Avalanche Energy Single Pulsed (Note 3)	E_{AS}	506	mJ
Power Dissipation (TA = 25°C, Steady State)	P_D	60	W
Operating junction and storage temperature	T_J, T_{STG}	-55 ~ +150	$^\circ\text{C}$

Notes: 1. Absolute maximum ratings are those values beyond which the device could be permanently damaged.

Absolute maximum ratings are stress ratings only and functional device operation is not implied.

2. Repetitive Rating: Pulse width limited by maximum junction temperature.

3. L=0.5mH, IAS = 45A, VDD = 90V, RG = 25 Ω , Starting $T_J = 25^\circ\text{C}$

Thermal Resistance

Parameter	Symbols	Ratings	Units
Thermal resistance, junction – case.	R_{thJC}	2.08	$^\circ\text{C}/\text{W}$
Thermal resistance, junction – ambient(min. footprint)	R_{thJA}	63	$^\circ\text{C}/\text{W}$



Electrical Characteristics (Ta=25°C, Unless Otherwise Specified)

Parameter	Symbols	Test Conditions	Min	Typ	Max	Units
Off Characteristics						
Drain-Source Breakdown Voltage	BV_{DSS}	$V_{GS}=0V, I_D=250\mu A$	60			V
Drain-Source Leakage Current	I_{DSS}	$V_{DS}=60V, V_{GS}=0V$			1.0	μA
Gate- Source Leakage Current	I_{GSS}	$V_{GS}=\pm 20V, V_{DS}=0V$			± 100	nA
On Characteristics						
Gate Threshold Voltage	$V_{GS(TH)}$	$V_{DS}=V_{GS}, I_D=250\mu A$	1.0		2.5	V
Static Drain-Source On-State Resistance	$R_{DS(ON)}$	$V_{GS}=10V, I_D=20A$		2.2	3.0	$m\Omega$
Transconductance	g_{fs}	$V_{DS}=10V, I_D=20A$		44		S
Dynamic Characteristics						
Input Capacitance	C_{ISS}	$V_{DS}=30V,$		6948		μF
Output Capacitance	C_{OSS}	$V_{GS}=0V,$		1093		μF
Reverse Transfer Capacitance	C_{RSS}	$f=1.0MHz$		204		μF
Gate resistance	R_G			4.0		Ω
Switching Characteristics						
Total Gate Charge (Note 1)	Q_G	$V_{DS}=30V, V_{GS}=10V,$		99		nC
Gate-Source Charge	Q_{GS}	$I_D=25A(NOTE1,2)$		16		nC
Gate-Drain Charge	Q_{GD}			27		nC
Turn-On Delay Time (Note 1)	$t_{D(ON)}$	$V_{DS}=30V, V_{GS}=10V,$		14		ns
Turn-On Rise Time	t_R	$R_G=4.5\Omega, I_D=25A$		36		ns
Turn-Off Delay Time	$t_{D(OFF)}$	(NOTE1,2)		75		ns
Turn-Off Fall Time	t_F			50		ns
Drain-source Diode Characteristics And Maximum Ratings						
Drain-Source Diode Forward Voltage (Note 1)	V_{SD}	$I_{SD}=20A, V_{GS}=0V$			1.2	V
Diode continuous forward current	I_S				100	A
Reverse Recovery time	t_{rr}	$V_{GS}=0V, I_{SD}=25A$		67		nS
Reverse Recovery Charge	Q_{rr}	$di/dt=100A/us$		90		nC

Notes:

1. Pulse Test: Pulse width $\leq 300\mu s$, Duty cycle $\leq 2\%$.
2. Essentially independent of operating temperature.



Test Circuits and waveforms

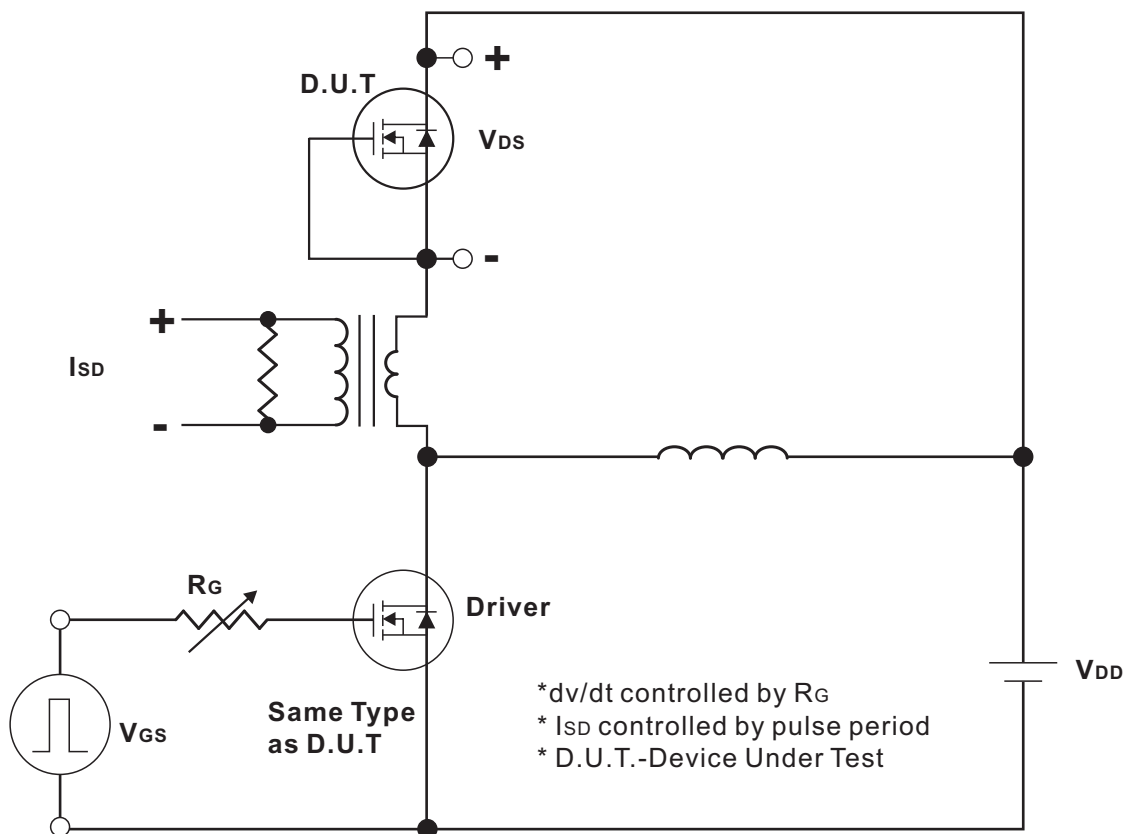

Peak Diode Recovery dv/dt Test Circuit

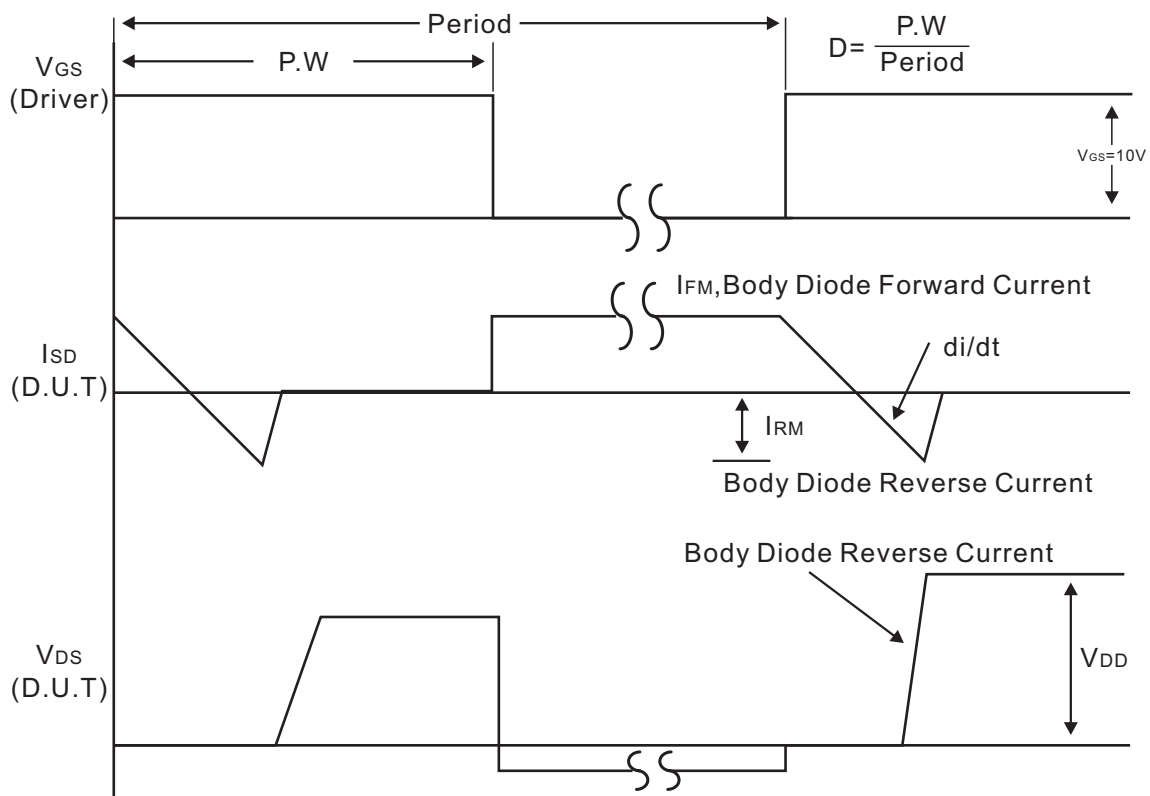

Body Diode Forward Voltage Drop
Peak Diode Recovery dv/dt Waveforms



Test Circuits and waveforms

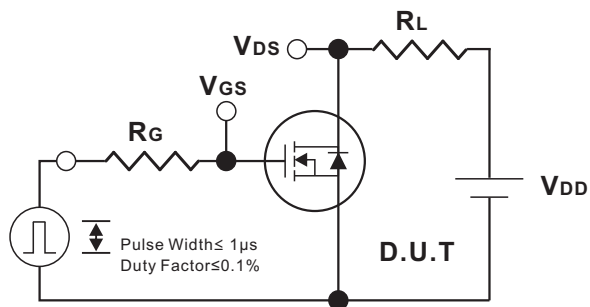

Switching Test Circuit

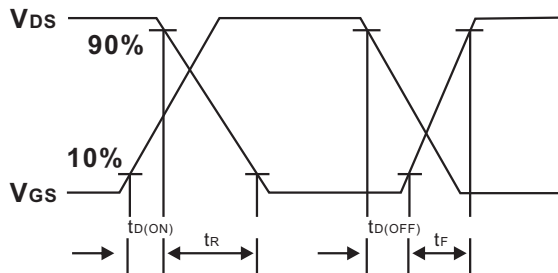

Switching Waveforms

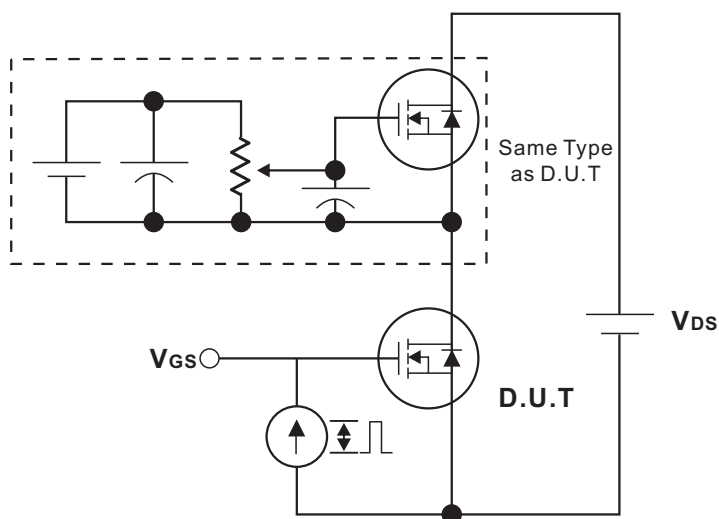

Gate Charge Test Circuit

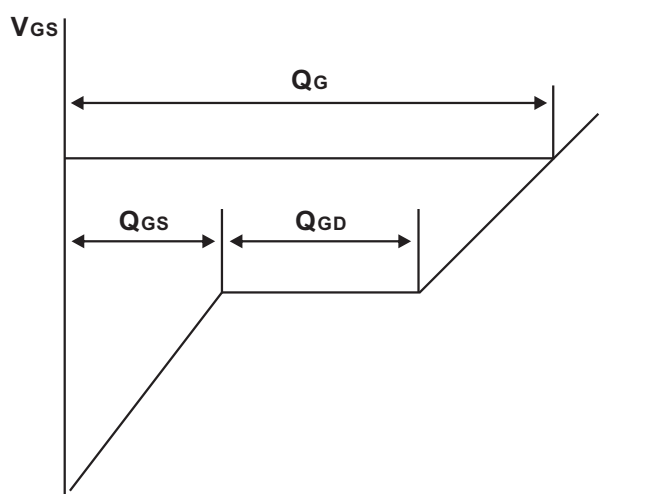

Charge
Gate Charge Waveform

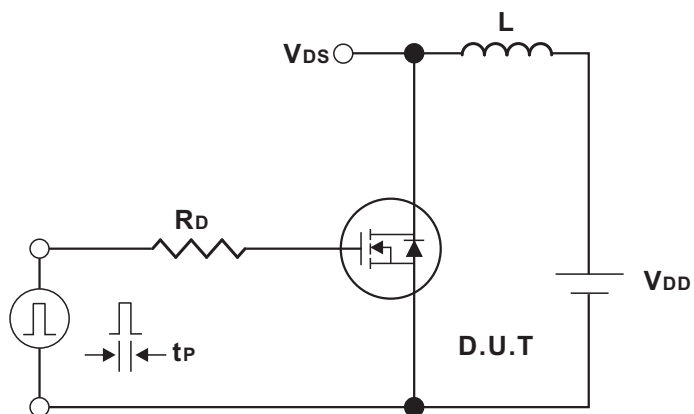

Unclamped Inductive Switching Test Circuit

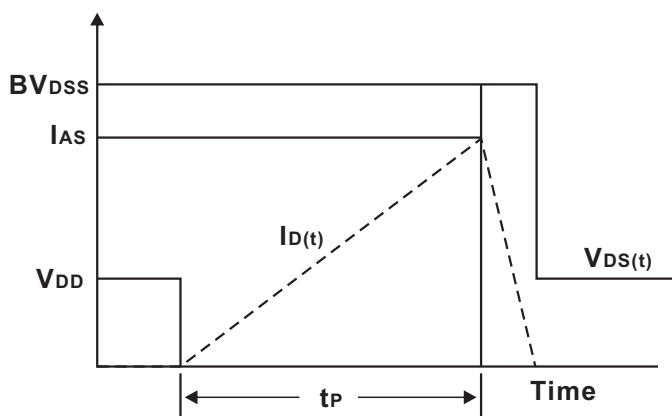

Unclamped Inductive Switching Waveforms



Typical Characteristics

Fig.1 Output characteristics

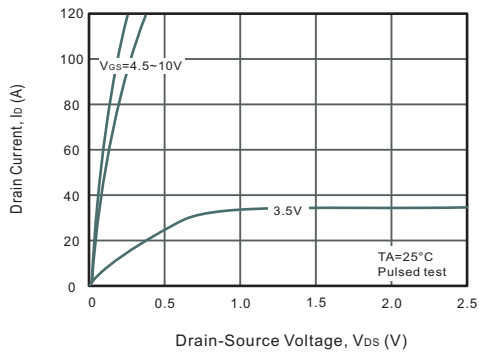

Fig.2 Power Dissipation

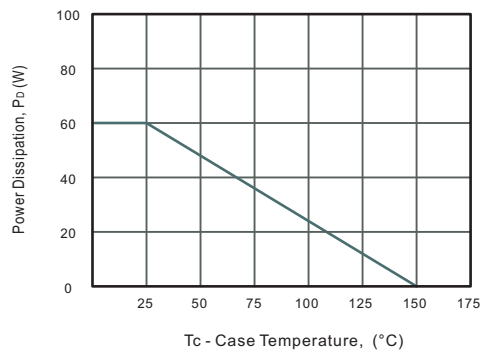

Fig.3 Drain Current Derating

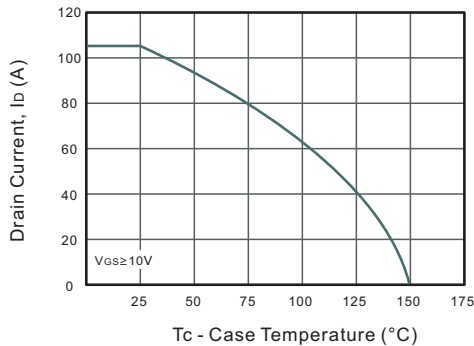

Fig.4 Drain-Source On-Resistance vs. Drain Current

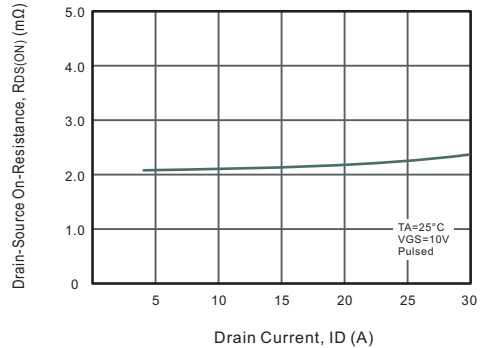

Fig.5 Gate Threshold Voltage vs. Junction Temperature

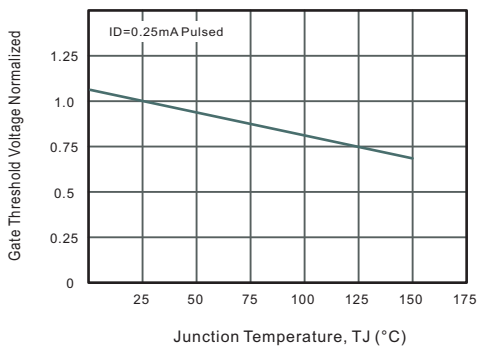

Fig.6 Body-diode Forward Characteristics

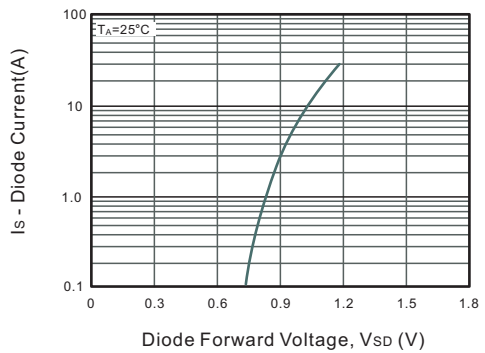

Fig.7 Drain-Source On-Resistance vs. Junction Temperature

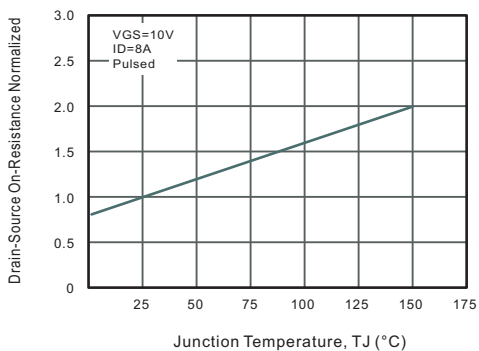
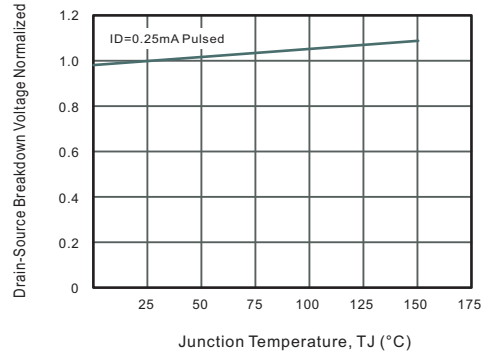

Fig.8 Breakdown Voltage vs. Junction Temperature





Typical Characteristics

Fig.11 Safe Operating Area

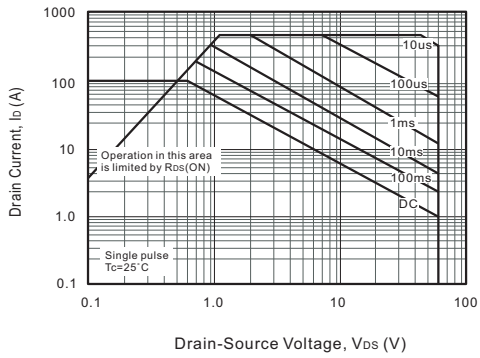

Fig.10 Gate Charge Characteristics

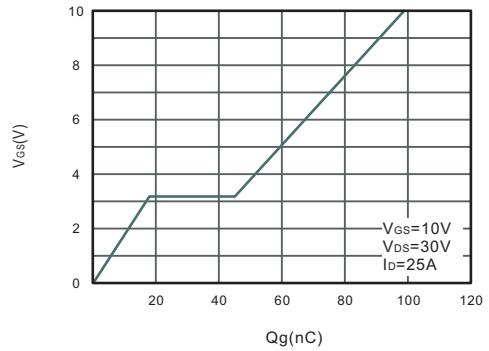

Fig.11 Capacitance Characteristics

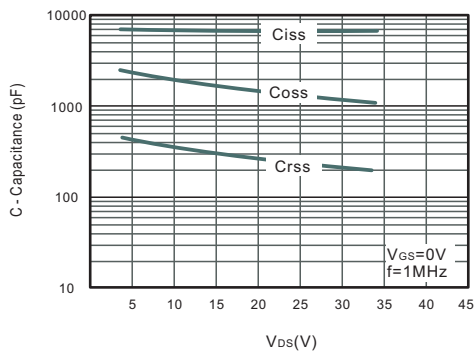
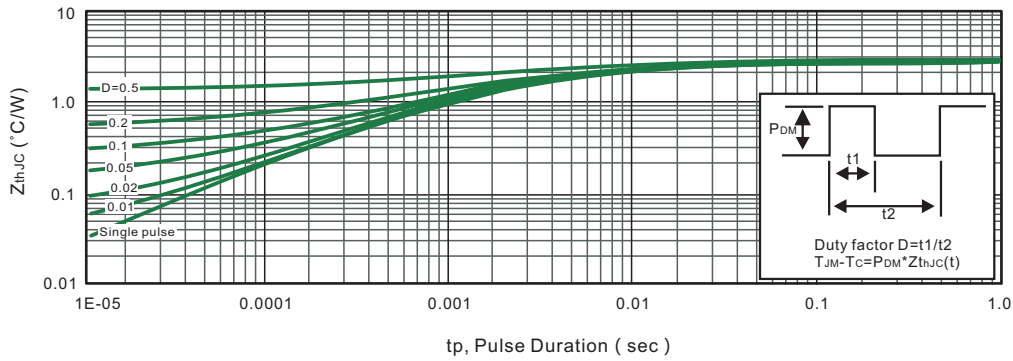

Fig.12 Max. Transient Thermal Impedance





Package Outline
Plastic surface mounted package;8 leads

PDFN5060-8L

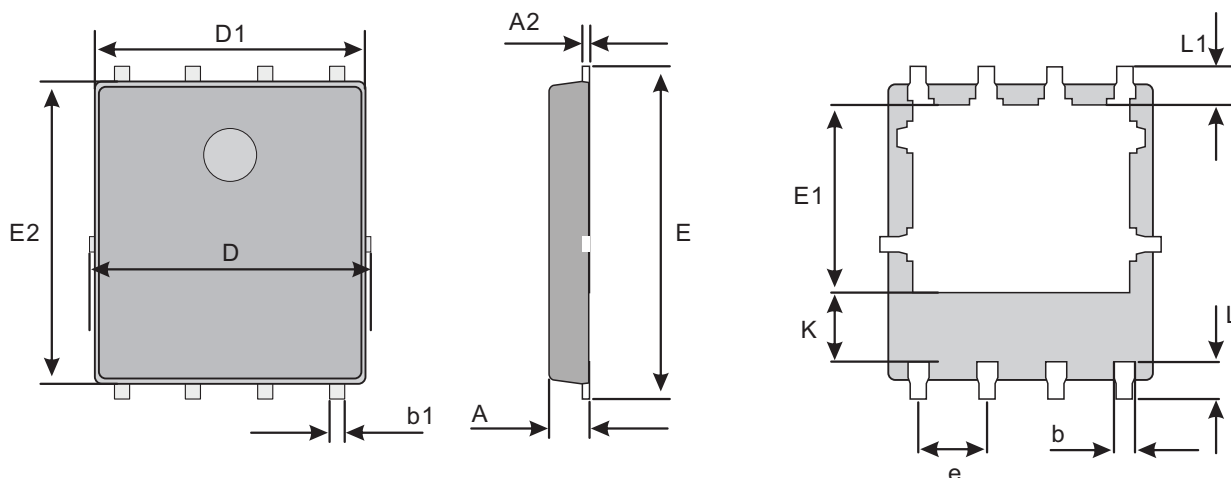

Mechanical data

UNIT		A	A2	b	b1	D	D1	E	E1	E2	e	K	L	L1
mm	max	1.1	0.304	0.4 ref.	0.4	5.3	5.24	6.35	3.675	6.09	1.27 typ.	1.29 typ.	0.785	0.7 typ.
	typ	1.0	0.254		0.3	5.15	5.04	6.15	3.475	5.89			0.685	
	min	0.9	0.204		0.2	5.0	4.84	5.95	3.275	5.69			0.585	
mil	max	43	12	16 ref.	16	209	206	250	145	240	50 typ.	51 typ.	31	28 typ.
	typ	39	10		12	203	198	242	137	232			27	
	min	35	8		8	197	191	234	129	224			23	

Marking Diagram

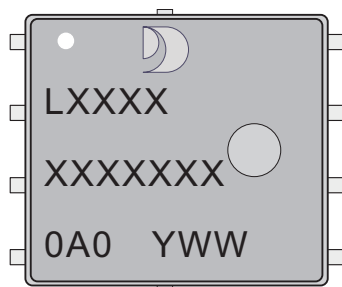

- Jingdao Logo
- Unmarkable Surfacea
- Pin1 Mark
- LXXXX XXXXXXXX: Marking code
- 0A0: Traceability code
- YWW: Y: Years(0~9)
- WW: Week



Important Notice and Disclaimer

Jingdao Microelectronics reserves the right to make changes to this document and its products and specifications at any time without notice. Customers should obtain and confirm the latest product information and specifications before final design, purchase or use.

Jingdao Microelectronics makes no warranty, representation or guarantee regarding the suitability of its products for any particular purpose, not does Jingdao Microelectronics assume any liability for application assistance or customer product design.

Jingdao Microelectronics does not warrant or accept any liability with products which are purchased or used for any unintended or unauthorized application.

No license is granted by implication or otherwise under any intellectual property rights of Jingdao Microelectronics.

Jingdao Microelectronics products are not authorized for use as critical components in life support devices or systems without express written approval of Jingdao Microelectronics.