

Fast Recovery Epi Diodes
Reverse Voltage – 400 Volts
Forward Current – 40 Amperes

Features

- High frequency operation
- High surge forward current capability
- High purity, high temperature epoxy encapsulation for enhanced mechanical strength and moisture resistance
- Guard ring for enhanced ruggedness and long term reliability
- Solder dip 275 °C max. 7s, per JESD 22-B106

Mechanical data

- Case: TO-247-3L
- Approx. Weight: 6.3g (0.22oz)
- Lead free finish, RoHS compliant
- Case Material: “Green” molding compound, UL flammability classification 94V-0, “Halogen-free”.

TO-247-3L

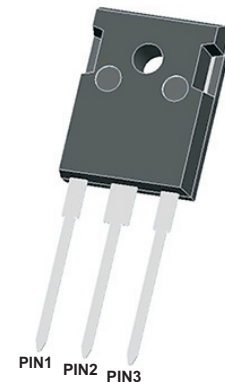

SYMBOL

ROHS
COMPLIANT



MAXIMUM RATINGS AND ELECTRICAL CHARACTERISTICS

Ratings at 25°C ambient temperature unless otherwise specified

PARAMETER	Symbols	MUR4040LWA	Units
Maximum Recurrent Peak Reverse Voltage	V_{RRM}	400	V
Maximum RMS voltage	V_{RMS}	280	V
Maximum DC blocking Voltage	V_{DC}	400	V
Maximum Average Forward Rectified Current @Tc=100°C	$I_{F(AV)}$	20 40	A
Peak Forward Surge Current, 8.3ms Single Half Sine-wave Superimposed on Rated Load (JEDEC method)	I_{FSM}	270	A
Instantaneous forward voltage at 20A	V_F	1.3	V
Maximum instantaneous reverse current at rated DC blocking voltage	I_R	10 500	uA
Maximum Reverse Recovery Time NOTE 1	trr	35	ns
Maximum Thermal Resistance Junction To Case	$R_{\theta JC}$	4	°C/W
Operation Junction Temperature and Storage Temperature	T_j, T_{stg}	-55 ~ +150	°C

NOTE 1: Reverse recovery test conditions $I_F=0.5A, I_R=1.0A, I_{rr}=0.25A$



Fig.1 TYPICAL FORWARD CURRENT DERATING CURVE

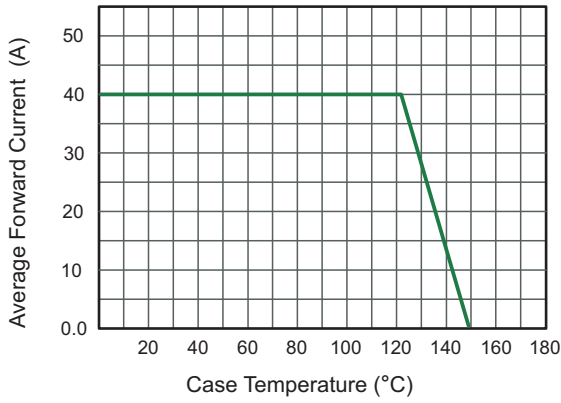

Fig.2 Typical Reverse Characteristics

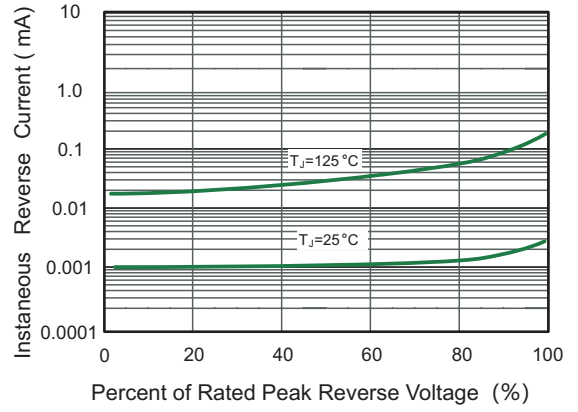

Fig.3 Typical Forward Characteristics

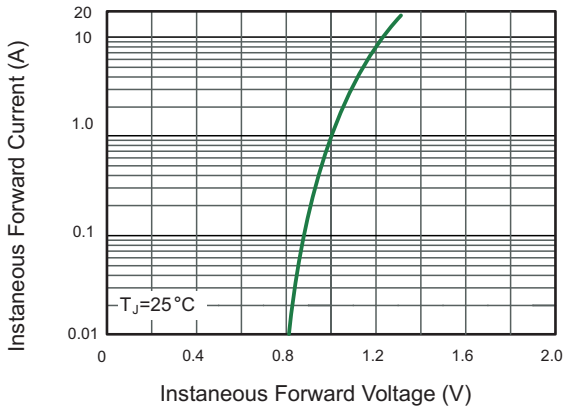
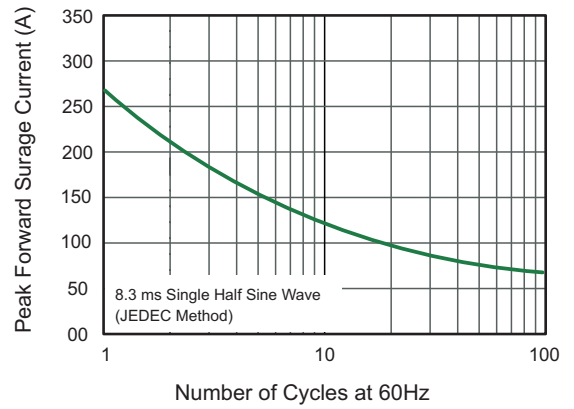

Fig.4 Maximum Non-Repetitive Peak Forward Surge Current





PACKAGE OUTLINE

Plastic Through hole package; 3 leads

TO-247-3L

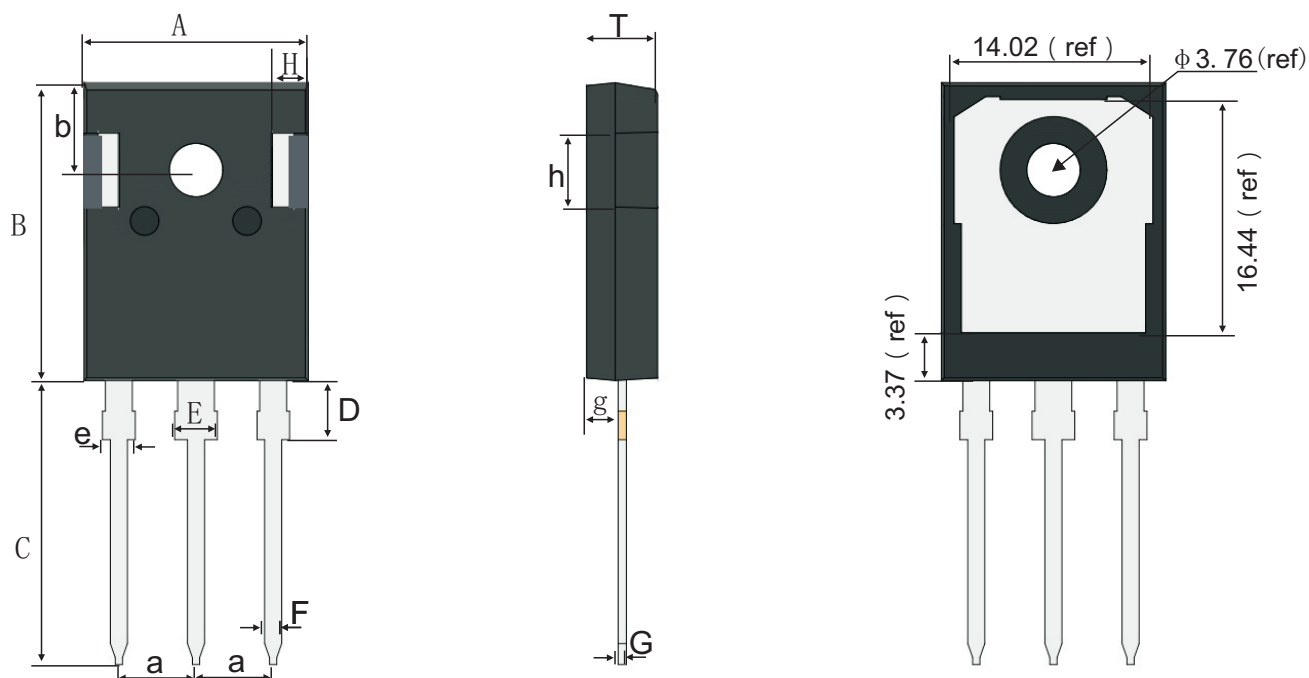

TO-247-3L mechanical data

UNIT		A	B	b	C	D	E	e	F	g	G	T	t	a	H	h
mm	max	16.01	21.18	6.26	20.2	4.25	3.15	2.20	1.30	2.49	0.70	5.20	2.21	5.54	2.71	5.37
	typ	15.81	20.98	6.16	20.0	4.15	3.00	2.05	1.20	2.39	0.60	5.00	2.01	5.44	2.51	5.17
	min	15.61	20.78	6.06	19.8	4.05	2.85	1.90	1.10	2.29	0.50	4.80	1.81	5.34	2.31	4.97
mil	max	630	834	246	795	167	124	87	51	98	28	205	87	218	107	211
	typ	622	826	243	787	163	118	81	47	94	24	197	79	214	99	204
	min	615	818	239	780	159	112	75	43	90	20	189	71	210	91	196

MARKING DIAGRAM

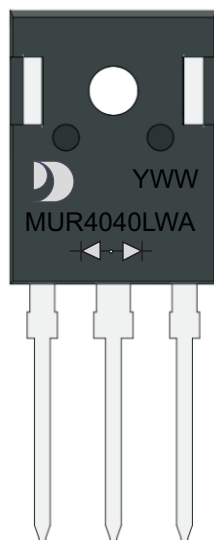

YWW: Date Code
Y: Years(0~9)
WW: Week
MUR4040LWA: Product name
(NOTE: The weekly code is based on the actual number of weeks in the calendar year.)



Important Notice and Disclaimer

Jingdao Microelectronics reserves the right to make changes to this document and its products and specifications at any time without notice. Customers should obtain and confirm the latest product information and specifications before final design, purchase or use.

Jingdao Microelectronics makes no warranty, representation or guarantee regarding the suitability of its products for any particular purpose, nor does Jingdao Microelectronics assume any liability for application assistance or customer product design.

Jingdao Microelectronics does not warrant or accept any liability with products which are purchased or used for any unintended or unauthorized application.

No license is granted by implication or otherwise under any intellectual property rights of Jingdao Microelectronics.

Jingdao Microelectronics products are not authorized for use as critical components in life support devices or systems without express written approval of Jingdao Microelectronics.