



SiC Schottky Diode

Product Summary

V_{RRM}	650V
$I_F(T_c 150^\circ\text{C})$	6A
Q_c	19.5 nC

Features

- Low conduction loss due to low VF
- Extremely low switching loss by tiny QC
- Essentially No Switching Losses
- Increased Power Density
- Enabling Higher Switching Frequency
- Lead Free Finish, RoHS Compliant

Applications

- Switch Mode Power Supplies
- Uninterruptible Power Supplies
- Motor Drivers
- Power factor correction

Maximum Ratings

Ratings At 25°C Ambient Temperature Unless Otherwise Specified

Parameter	Symbols	SC06065DSH	Test Conditions	Units
Maximum Recurrent Peak Reverse Voltage	V_{RRM}	650	$T_c=25^\circ\text{C}$	V
Surge Peak Reverse Voltage	V_{RSM}	650	$T_c=25^\circ\text{C}$	V
Maximum DC Blocking Voltage	V_{DC}	650	$T_c=25^\circ\text{C}$	V
Forward Current	I_F	22	$T_c \leq 25^\circ\text{C}$	A
		9	$T_c \leq 135^\circ\text{C}$	
		6	$T_c \leq 150^\circ\text{C}$	
Non-Repertive Forward Surge Current	I_{FSM}	45	$T_c=25^\circ\text{C}$, $T_p=10\text{ms}$, Half Sine Wave	A
Power Dissipation	PD	103	$T_c=25^\circ\text{C}$	W
Operating Junction Temperature Range	T_j	-55 ~ +175		$^\circ\text{C}$
Storage Temperature Range	T_{stg}	-55 ~ +175		$^\circ\text{C}$

TO-252W(Prefix :D)

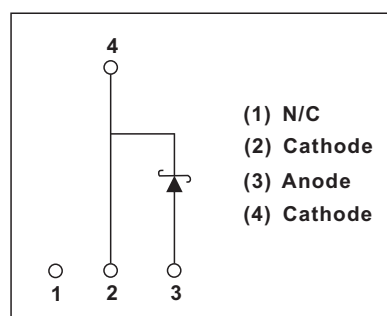
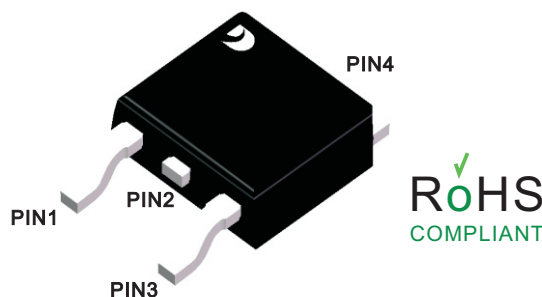



Electrical Characteristics

Ratings At 25°C Ambient Temperature Unless Otherwise Specified

Parameter	Symbols	Test Conditions	Min	Typ	Max	Units
Instantaneous forward voltage per leg	V_F	$I_F=6A, T_J=25^\circ C$ $I_F=6A, T_J=175^\circ C$		1.55 2.2	1.8 2.7	V
Reverse current per leg	I_R	$V_R=650V, T_J=25^\circ C$ $V_R=650V, T_J=175^\circ C$		1 12	20 80	μA
Total Capacitance	C	$V_R=0V, T_J=25^\circ C, f=1MHz$		185		pF
Total Capacitive Charge	Q_C	$V_R=400V, T_J=25^\circ C$ $\int_0^{V_R} C(V) dv$		19.5		nC

Thermal Characteristics

Parameter	Symbols	TYP	Units
Thermal Resistance from Junction to Case	$R_{\theta JC}$	1.45	$^\circ C/W$

Typical Performance

Figure 1. Total Capacitance vs. Reverse Voltage

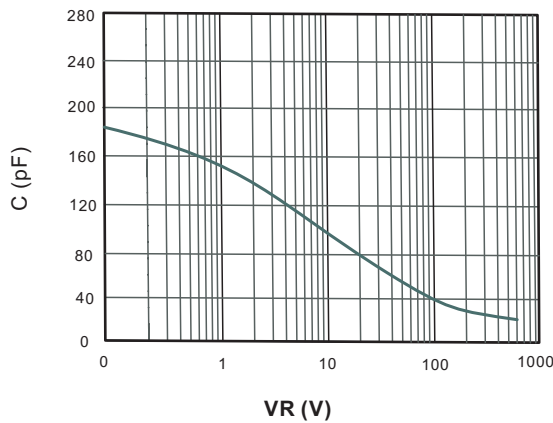

Figure 2. Total Capacitive Charge vs. Reverse Voltage

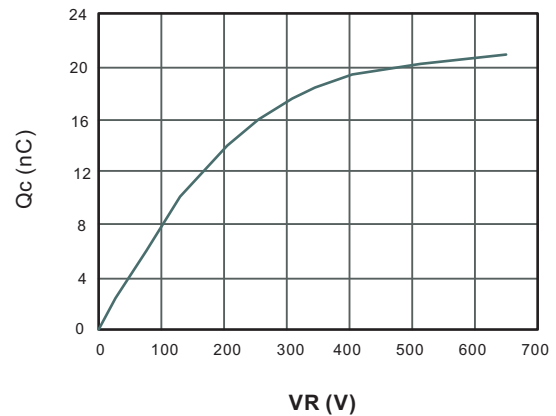



Fig.3 Typical Forward Current Derating Curve

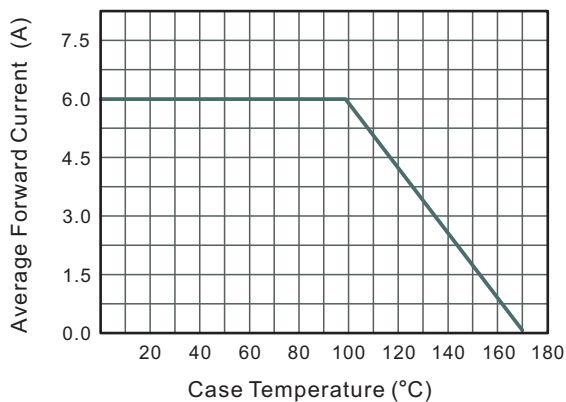

Fig.4 Power Dissipation

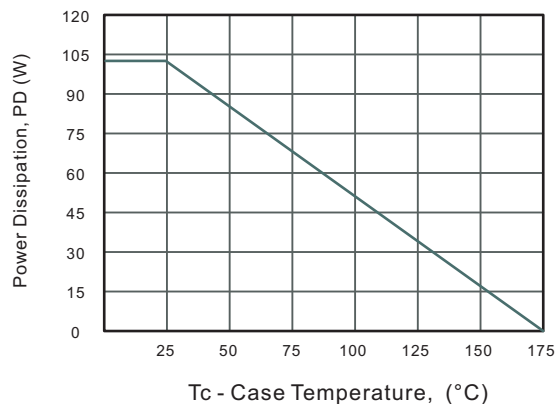

Fig.5 Typical Forward Characteristic(per leg)

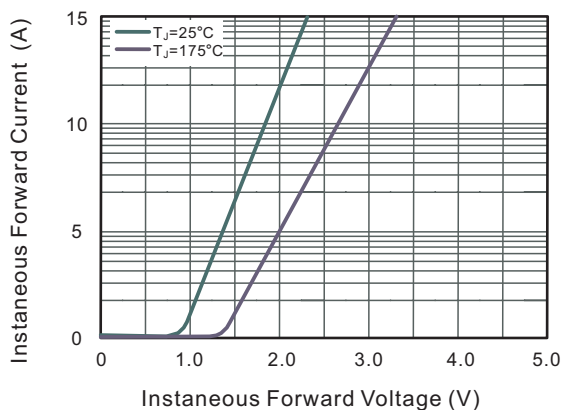

Fig.6 Typical Reverse Characteristics

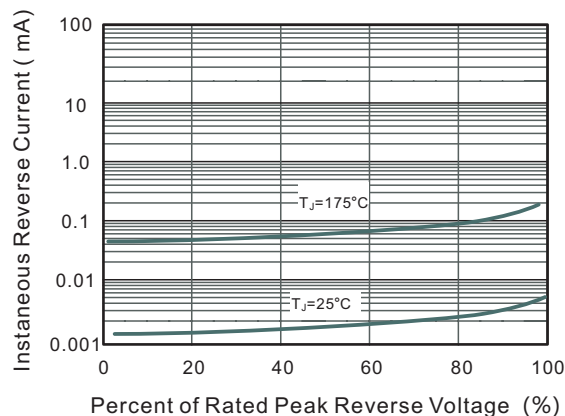

Fig.7 Max. Transient Thermal Impedance

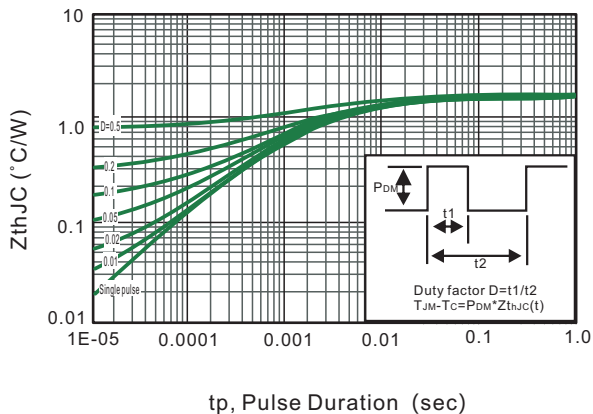
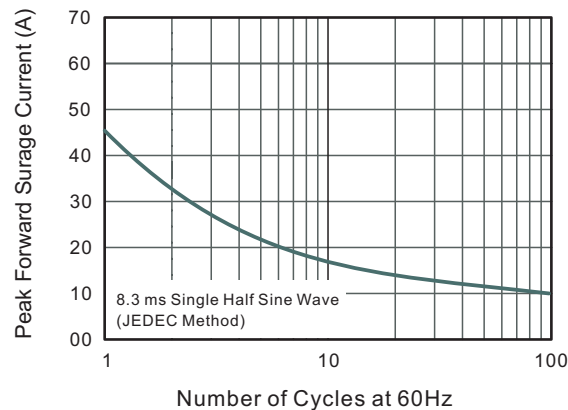
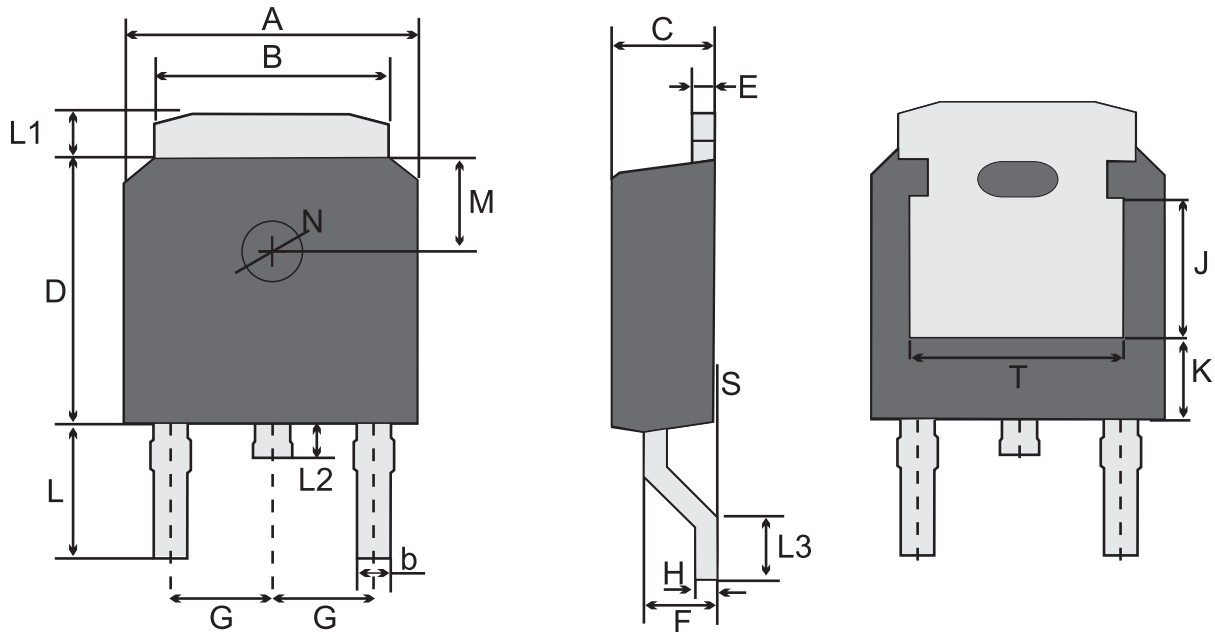

Fig.8 Maximum Non-Repetitive Peak Forward Surge Current





TO-252W(D-PAK) Package Outline Dimensions



TO-252W(D-PAK)Mechanical data

UNIT		A	B	b	C	D	E	F	G	H	L	L1	L2	L3	S	M	N	J	T	K
mm	max	6.7	5.53	0.86	2.5	6.3	0.61	1.87	2.3 typ.	0.55	3.0	1.2	1.0	1.75	0.23	1.8 typ.	1.3 typ.	3.2 ref.	4.83 ref.	1.8 ref.
	typ	6.6	5.33	0.76	2.3	6.1	0.51	1.57		0.50	2.8	1.0	0.8	1.30	0.15					
	min	6.3	5.13	0.66	2.1	5.9	0.41	1.27		0.45	2.6	0.8	0.6	1.0	/					
mil	max	264	218	34	98	248	24	74	91 typ.	22	118	47	39	69	9.1	71 typ.	51 typ.	126 ref.	190 ref.	71 ref.
	typ	260	210	30	91	240	20	62		20	110	39	31	51	5.9					
	min	248	202	26	83	232	16	50		18	102	31	24	39	/					

Marking

Type number	Marking code
SC06065DSH	SC06065DSH



Important Notice and Disclaimer

Jingdao Microelectronics reserves the right to make changes to this document and its products and specifications at any without notice.

Customers should obtain and confirm the latest product information and specifications before final, purchase or use.

Jingdao Microelectronics makes no warranty, representation or guarantee regarding the suitability of its products for any particular purpose, not does Jingdao Microelectronics assume any liability for application assistance or customer product design.

Jingdao Microelectronics does not warrant or accept any liability with products which are purchased or used for any unintended or unauthorized application.

No license is granted by implication or otherwise under any intellectual property rights of Jingdao Microelectronics.

Jingdao Microelectronics products are not authorized for use as critical components in life support devices or systems without express written approval of Jingdao Microelectronics.