



DESCRIPTION

The JD431/JD431SWR are three-terminal adjustable shunt regulators with specified thermal stability. The output voltage may be set to any value between V_{ref} and 36V with two external resistors. Active output circuitry provides a very sharp turnon characteristic, making these devices excellent replacements for zener diodes in many applications.

Features

- The output voltage can be adjusted 2.5V to 36V
- The JD431/JD431SWR precision reference is offered in two voltage tolerance: 0.5% and 1.0%.
- Fast turn-on response
- Sink current capability 1mA to 100mA
- Low output noise
- Industrial temperature range
- Qualified to AEC-Q101 Standards for High Reliability

Application

- Shunt regulator
- High-current shunt regulator
- Precision current limiter

PINNING

PIN	DESCRIPTION
A	ANODE
K	CATHODE
R	REFERENCE

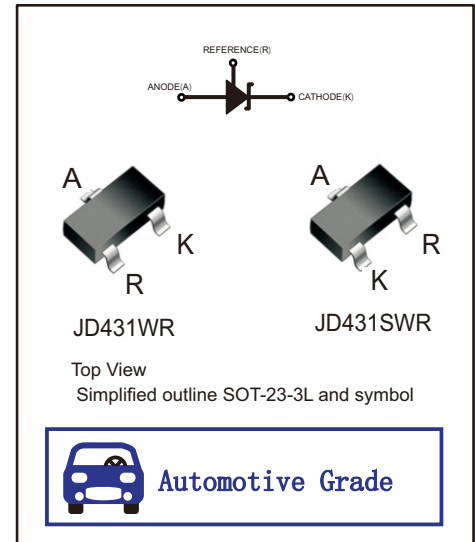

Absolute Maximum Ratings (Note 1)

Symbol	Parameter		Rating	Unit
V_{KA}	Cathode Voltage		36	V
I_{KA}	Cathode Current Range (Continuous)		-100 to 150	mA
I_{REF}	Reference Input Current Range		0.05~10	mA
P_D	Power Dissipation		Z, R Package: 770	mW
			N Package: 300	
θ_{JA}	Thermal Resistance (Junction to Ambient)	SOT-23-3L	380	$^{\circ}C/W$
T_J	Junction Temperature		+150	$^{\circ}C$
T_{STG}	Storage Temperature Range		-65 to +150	$^{\circ}C$
ESD	ESD (Human Body Model)		2000	V

Note 1: Stresses greater than those listed under "Absolute Maximum Ratings" may cause permanent damage to the device. These are stress ratings only, and functional operation of the device at these or any other conditions beyond those indicated under "Recommended Operating Conditions" is not implied. Exposure to "Absolute Maximum Ratings" for extended periods may affect device reliability.



Recommended Operating Conditions

Symbol	Parameter	Min	Max	Unit
V_{KA}	Cathode Voltage	V_{REF}	36	V
I_{KA}	Cathode Current	1.0	100	mA
T_A	Operating Ambient Temperature Range	-25	+85	°C

Electrical Characteristics (@ $T_A = +25^\circ\text{C}$, unless otherwise specified.)

Symbol	Parameter	Conditions	Min	Typ	Max	Unit			
V_{REF}	Reference Voltage	$V_{KA} = V_{REF}, I_{KA} = 10\text{mA}$		2.488	2.500	2.512	V		
								0.5%	JD431AWR
									JD431SAWR
								1%	JD431BWR
				2.475	2.500	2.525			
ΔV_{REF}	Deviation of Reference Voltage Over Full Temperature Range	$V_{KA} = V_{REF}, I_{KA} = 10\text{mA}$ $T_{min} \leq T_A \leq T_{max}$	—	4.5	17	mV			
$\frac{\Delta V_{REF}}{\Delta V_{KA}}$	Ratio of Change in Reference Voltage to the Change in Cathode Voltage	$I_{KA} = 10\text{mA}$	$\Delta V_{KA} = 10\text{V to } V_{REF}$	—	-1.0	-2.7	mV/V		
			$\Delta V_{KA} = 36\text{V to } 10\text{V}$	—	-0.5	-2.0			
I_{REF}	Reference Current	$I_{KA} = 10\text{mA}, R_1 = 10\text{k}\Omega,$ $R_2 = \infty$	—	1.5	4	μA			
ΔI_{REF}	Deviation of Reference Current Over Full Temperature Range	$I_{KA} = 10\text{mA}, R_1 = 10\text{k}\Omega$ $R_2 = \infty, T_A = \text{full Temperature}$	—	0.4	1.2	μA			
$I_{KA}(\text{Min})$	Minimum Cathode Current for Regulation	$V_{KA} = V_{REF}$	—	0.45	1.0	mA			
$I_{KA}(\text{Off})$	Off-state Cathode Current	$V_{KA} = 36\text{V}, V_{REF} = 0$	—	0.05	1.0	μA			
Z_{KA}	Dynamic Impedance	$V_{KA} = V_{REF}, I_{KA} = 1 \text{ to } 100\text{mA},$ $f \leq 1.0\text{kHz}$	—	0.15	0.5	Ω			



FIGURE 1. TEST CIRCUIT FOR $V_{KA} = V_{REF}$

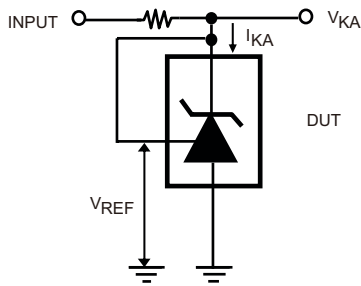

FIGURE 2. TEST CIRCUIT FOR $V_{KA} \geq V_{REF}$

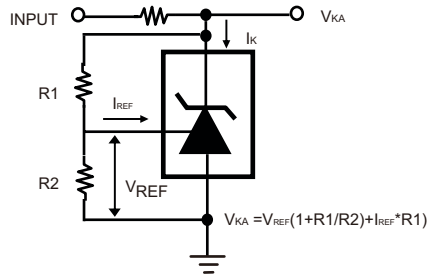

FIGURE 3. TEST CIRCUIT FOR I_{KA} (OFF)

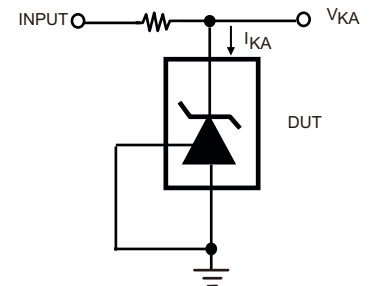

FIGURE 4. TEST CIRCUIT FOR PULSE RESPONSE

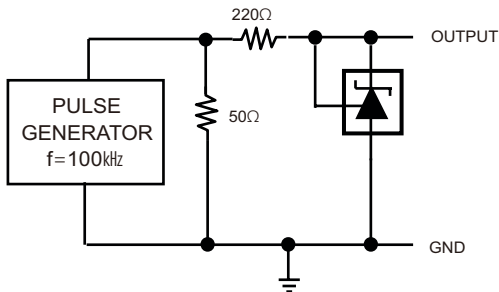
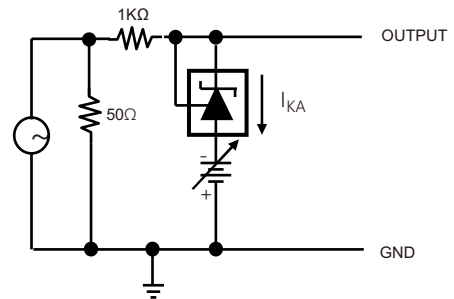

FIGURE 5. TEST CIRCUIT REFERENCE IMPEDANCE





Typical Characteristics

Fig.1 CATHODE CURRENT VS CATHODE VOLTAGE

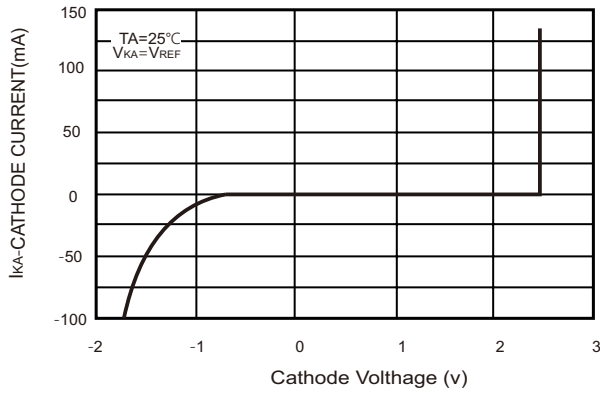

Fig.2 CATHODE CURRENT VS CATHODE VOLTAGE

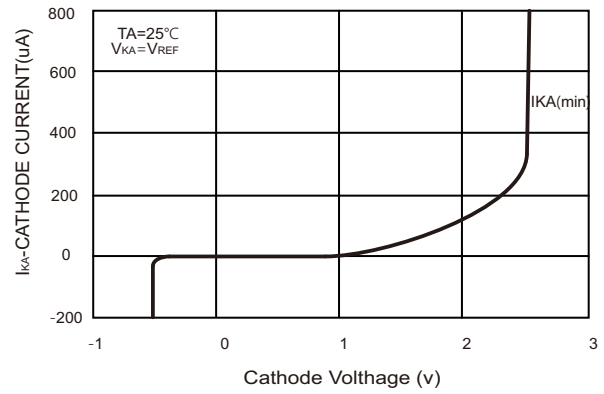

Fig.3 CHANGE IN REFERENCE INPUT VOLTAGE VS CATHODE VOLTAGE

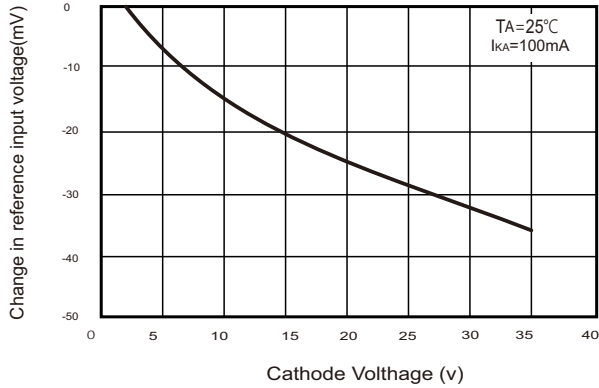

Fig.4 PULSE RESPONSE

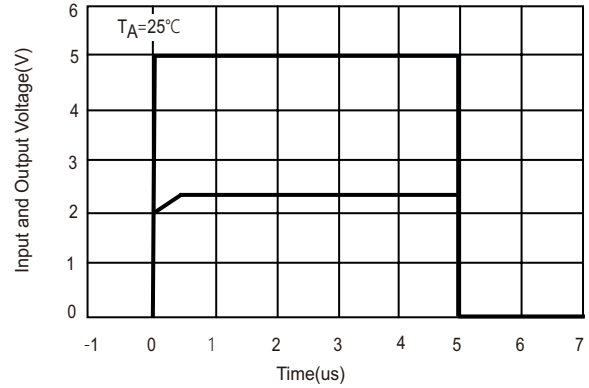

Fig.5 IMPEDANCE VS FREQUENCY

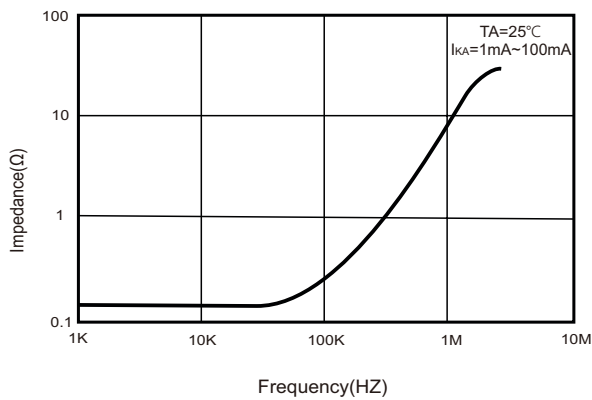
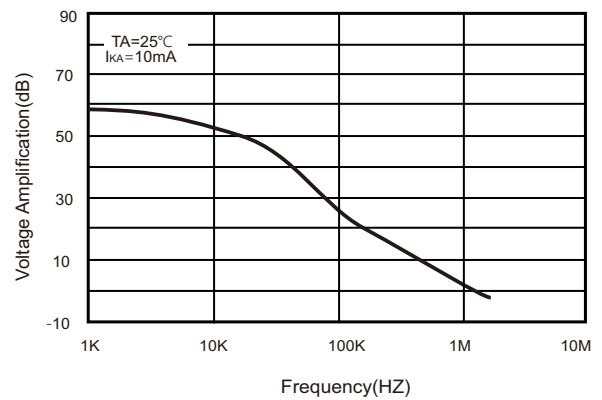
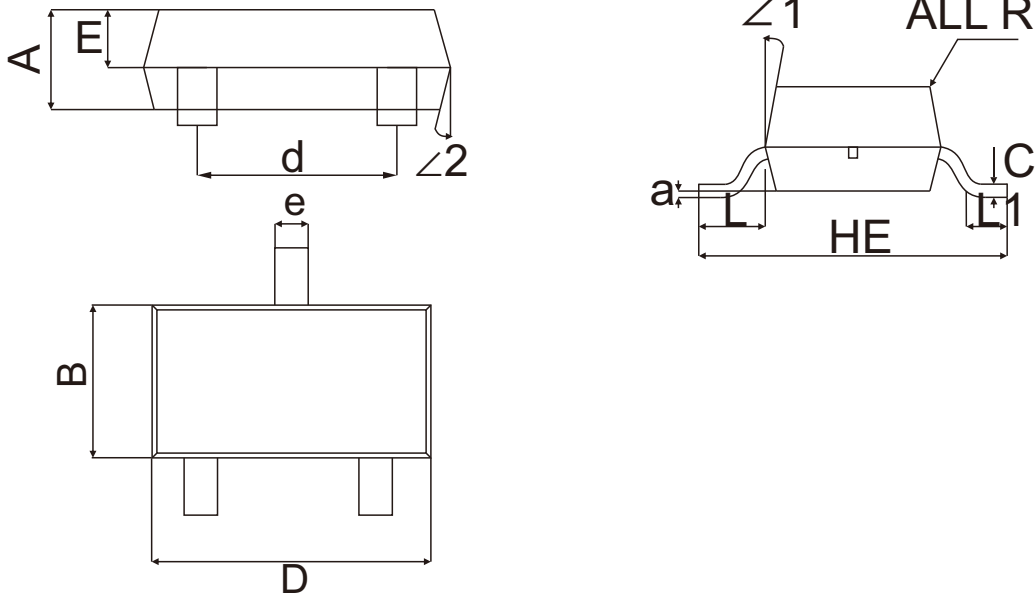

Fig.6 SMALL SIGNAL VOLTAGE AMPLIFICATION VS FREQUENCY





SOT-23-3L Package Outline Dimensions



Unit		A	B	C	HE	D	d	E	e	L	L1	a	R	$\angle 1$	$\angle 2$
mm	max	1.05	1.80	0.20	2.90	3.12	2.00	0.65	0.40	0.70	0.60	0.2 (ref)	R0.1 (ref)	12°	10°
	typ	0.95	1.60	0.15	2.80	2.92	1.90	0.55	0.35	0.60	/				
	min	0.85	1.40	0.10	2.70	2.72	1.80	0.45	0.30	0.50	0.20				
mil	max	41	71	8	114	123	79	26	16	28	24	8 (ref)	R4 (ref)	12°	10°
	typ	37	63	6	110	115	75	22	14	24	/				
	min	33	55	4	106	107	71	18	12	20	8				

The recommended mounting pad size

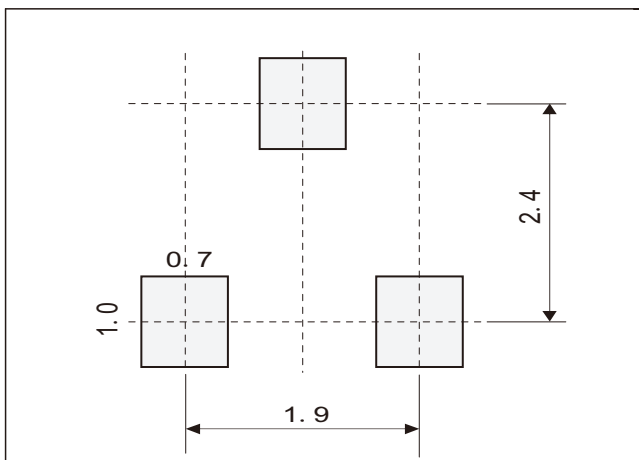

Marking

NumbType er	Marking code
JD431AWR	J431A
JD431BWR	J431B
JD431SAWR	431JA
JD431SBWR	431JB



Important Notice and Disclaimer

Jingdao Microelectronics reserves the right to make changes to this document and its products and specifications at any time without notice.

Customers should obtain and confirm the latest product information and specifications before final design, purchase or use.

Jingdao Microelectronics makes no warranty, representation or guarantee regarding the suitability of its products for any particular purpose, nor does Jingdao Microelectronics assume any liability for application assistance or customer product design.

Jingdao Microelectronics does not warrant or accept any liability with products which are purchased or used for any unintended or unauthorized application.

No license is granted by implication or otherwise under any intellectual property rights of Jingdao Microelectronics.

Jingdao Microelectronics products are not authorized for use as critical components in life support devices or systems without express written approval of Jingdao Microelectronics.